

Installation & Maintenance Manual

MONTIGO[®]
the art of **fireplaces**

Illume Inserts

INDOOR GAS FIREPLACE

30FID LINEAR

30FID TRADITIONAL

34FID LINEAR

34FID TRADITIONAL

IMPORTANT

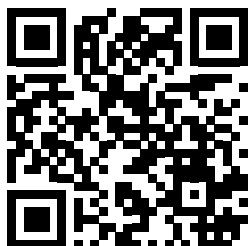

SCAN THE QR CODE OR VISIT THE WEBSITE TO VIEW THE MOST RECENT VERSION OF THE MANUAL

WWW.MONTIGO.COM/PRODUCT-GUIDES



- The installation of this fireplace must be done by a qualified and certified gas appliance installer.
- Check local codes and read all instructions prior to installation.

NOTICE

Installer: Leave this manual with the appliance.
Consumer: Retain this manual for future reference.

⚠ DANGER

Read and understand this manual. Improper installation, adjustment, alteration, service or maintenance can cause serious injury, property damage or even death. For assistance or additional information consult a qualified installer, service agency or the gas supplier.

⚠ WARNING

Some materials used in the manufacturing process of this product can expose you to Benzene which is known in the State of California to cause cancer and birth defects or other reproductive harm. For more information go to www.P65warnings.ca.gov

⚠ DANGER



HOT GLASS WILL CAUSE BURNS.
DO NOT TOUCH GLASS UNTIL COOLED.
NEVER ALLOW CHILDREN TO TOUCH GLASS.

A barrier designed to reduce the risk of burns from the hot viewing glass is provided with this appliance and must be installed for the protection of children and other at-risk individuals.

Canada

ENERGUIDE

Look for the EnerGuide Gas Fireplace Energy Efficiency Rating in this brochure

Based on CSA P.4.1-15

Safety Alert Key

DANGER

Indicates a hazardous situation which, if not avoided, WILL result in death or serious injury or property damage.

WARNING

Indicates a hazardous situation which, if not avoided, COULD result in death or serious injury or property damage.

CAUTION

Indicates a hazardous situation which, if not avoided, WILL result in minor or moderate injury.

NOTICE

Indicates practices that are important, but not related to personal injury.

Part Number	Input Rating	Gas Supply Pressure	Manifold Pressure High	Manifold Pressure Low	Orifice Size (DMS)	Pilot Orifice Size (No.)	Electrical Requirement	Vent Size	Minimum Vent Length	Maximum Vent Length	Efficiency P.4. 1-15	Control Type	Fuse Specification	Certification(s)	
30FIDN-L-F [NG]	30FIDNIL-01	24,000	7" WC	3.5"	2.2"	41	62	115 VAC, 60Hz	3"OUT 3"IN	10'	36'	77.6%	SIT Proflame 2	3.15 Amps	
30FIDL-L-F [Propane]	30FIDLIL-01	23,000	11" WC	10"	6.4"	54	35	115 VAC, 60Hz	3"OUT 3"IN	10'	36'	79%	SIT Proflame 2	3.15 Amps	CSA/ANSI Z21.88-2019/ CSA 2.33-2019 VENTED GAS FIREPLACE HEATERS
30FIDN-S-F [NG]	30FIDNIS-01	24,000	7" WC	3.5"	2.2"	41	62	115 VAC, 60Hz	3"OUT 3"IN	10'	36'	78.8%	SIT Proflame 2	3.15 Amps	
30FIDL-S-F [Propane]	30FIDLIS-01	23,000	11" WC	10"	6.4"	54	35	115 VAC, 60Hz	3"OUT 3"IN	10'	36'	80.1%	SIT Proflame 2	3.15 Amps	CSA 2.17-2017 GAS FIRED APPLIANCES FOR HIGH ALTITUDES
34FIDN-L-F [NG]	34FIDNIS-01	31,000	7" WC	3.5"	2.2"	41	62	115 VAC, 60Hz	4"OUT 3"IN	10'	36'	77.4%	SIT Proflame 2	3.15 Amps	CSA P.4.1-15 Fireplace Efficiency
34FIDL-L-F [Propane]	34FIDLIS-01	30,000	11" WC	10"	6.4"	54	35	115 VAC, 60Hz	4"OUT 3"IN	10'	36'	78.5%	SIT Proflame 2	3.15 Amps	
34FIDN-S-F [NG]	34FIDNIS-01	31,000	7" WC	3.5"	2.2"	41	62	115 VAC, 60Hz	4"OUT 3"IN	10'	36'	81.1%	SIT Proflame 2	3.15 Amps	
34FIDL-S-F [Propane]	34FIDLIS-01	30,000	11" WC	10"	6.4"	54	35	115 VAC, 60Hz	4"OUT 3"IN	10'	36'	82%	SIT Proflame 2	3.15 Amps	

Figure 1 Specifications

Contents

Safety Alert Key 2

 Section A: Before You Begin 4

 Warranty Information: See Appendix B..... 4

 Rating Plate Location..... 4

 Rating Plate Sample..... 5

Section 1: Product Dimensions..... 6

Section 2: Installation Dimensions 8

 Before You Begin..... 8

 Install Dimensions..... 8

 Clearances 8

 Clearances Cont. 9

 Non Combustible Board Install 9

Section 3: Venting 10

 Termination..... 10

 Co-linear to Co-axial Adaptor..... 10

 Venting..... 10

 Connectors 10

 Vent Configurations..... 11

 Steps for vent connection..... 11

Section 3: Installation..... 12

 Door Installation & Removal..... 12

 Propane Conversion..... 13

 Converting the gas regulator on the valve..... 13

 Converting the main burner orifice to Propane..... 15

 Converting the pilot orifice to Propane 15

 Gas line connection..... 16

 Emergency Shut-off Valve..... 16

 Fuel Supply + Manifold Pressure Checking 16

 Faceplate Installation 17

 Offset Faceplate Installation..... 20

POD - Pilot on Demand 21

 What is POD and CPI mode?..... 21

 Remote Continuous Pilot (CPI) Selection 21

 Installing the CPI Jumper Cable 21

 Levelling the Unit..... 22

 Connecting Power..... 22

 Battery Installation / Replacement..... 22

 Firestones or Fireglass Installation 22

 Speckled Stone Installation..... 23

 Driftwood Log Set Installation..... 24

 Brick Panel Installation..... 25

 Porcelain Panel Installation 25

 34FID Traditional Log Installation 26

 30FID Traditional Log Installation 28

 Initial Operation..... 30

 Pilot Flame Adjustment..... 30

 Master Override Switch..... 30

 Aeration Adjustment 32

Section 5: Wiring 33

Remote Operation 34

 Initializing the System for the first time..... 35

 Operating the System for the first time..... 35

 Continuous Pilot (CPI) Selection (Optional)..... 35

 Temperature Indication Display 35

 Turn On the Fireplace 35

 Turn Off the Fireplace 35

 Remote-Flame Control..... 36

 Room Thermostat (Remote Control Operation)..... 36

 Smart Thermostat (Remote Control Operation) 36

 Disabling Thermostat..... 37

 Key Lock..... 37

 Fan Speed Control 37

 Accent Light Control..... 37

Section 6: Maintenance 38

 Burner Removal (Linear)..... 38

 Burner Installation (Linear)..... 38

 Burner Removal (Traditional) 39

 Burner Installation (Traditional)..... 39

 Accent Light Replacement (Linear) 40

 Accent Light Replacement (Traditional)..... 40

 Optional Fan / Blower Replacement..... 41

 Window Cleaning / Screen Removal..... 43

 Battery Replacement..... 43

 Heat Exchanger Bypass..... 43

 Pilot Maintenance / Replacement..... 44

 Control Board Replacement..... 46

 Control Board Fuse Replacement..... 46

Section 7: Cleaning 47

 Cleaning..... 47

 Vent Maintenance / Inspection..... 47

Troubleshooting..... 48

Replacement Parts 48

Appendix B: Warranty 49

Appendix B: Warranty Continued 50

Appendix C: Amendment 51

(Gas Fireplace / Equipment sold in the State of Massachusetts)..... 51

Section A: Before You Begin

IMPORTANT MESSAGE: SAVE THESE INSTRUCTIONS

The Illume fireplaces must be installed in accordance with these instructions. Carefully read all the instructions in this manual first. Consult the Local Gas Branch to determine the need for a permit prior to starting the installation. It is the responsibility of the installer to ensure this fireplace is installed in compliance with the manufacturers instructions and all applicable codes.

NOTICE

Do not use this appliance if any part has been under water. Immediately call a qualified service technician to inspect the appliance and to replace any part of the control system and any gas control that has been under water

NOTICE

Due to high temperatures, the appliance should be located out of traffic and away from furniture and draperies

NOTICE

Children and adults should be alerted to the hazards of high surface temperature and should stay away to avoid burns or clothing ignition

NOTICE

A barrier designed to reduce the risk of burns from the hot viewing glass is provided with this appliance and shall be installed for the protection of children and other at-risk individuals

Warranty Information: See Appendix B

The Montigo warranty will be voided by, and Montigo disclaims any responsibility for, the following actions:

- Modification of the fireplace and/or components including Direct-Vent assembly or glass doors.
- Use of any component part not manufactured or approved by Montigo in combination with this Montigo fireplace system.
- Installation other than as instructed in this manual.

Consult your local Gas Inspection Branch on installation requirements for factory-built gas fireplaces. Installation & repairs should be done by a qualified contractor.

This appliance is equipped for altitudes from 0 - 4500 feet [0 - 1370 m]. For higher altitudes contact your Montigo dealer.

NOTICE

Clothing or other flammable material should not be placed on or near the appliance

NOTICE



Installation and repair should be done by a qualified service person. The appliance should be inspected before use and at least annually by a professional service person. More frequent cleaning might be required due to excessive lint from carpeting, bedding material, etc. It is imperative that control compartments, burners, and circulating air passageways of the appliance be kept clean

Rating Plate Location



Figure 1.2 Rating Plate location

Rating Plate Sample

Do Not Remove This Label
N'enlevez Pas Cette Étiquette

Type: **Vented Gas Fireplace Heater**

Not for use with solid fuel. / Pas pour l'usage avec le combustible solide.

Not for use with air filters. / Pas pour l'usage avec des filtres à air.

Model No. Modèle: 30FID-S-F

Part No: 30FIDNIS -01

Serial No: 2-1509114-000000

Manufacturer / Fabricant: Canadian Heating Products Inc., Langley BC, (www.montigo.com)
Montigo DelRay Corp., Ferrdale, WA. (www.montigo.com)

Tested To / Examiné À: CSA/ANSI Z21.88-2019 / CSA2.33-2019

Electrical Rating / Estimation Électrique: 115V / 1Ph / 60Hz /less than 12A

Altitude Rating / Estimation D'Altitude: N & H (0 - 4500 ft. / 0 - 1371 m.)

Fuel Type / Type De Carburant:

Natural Gas / Gaz Naturel

Propane / Gaz Propane

FOR USE WITH GLASS DOORS AND SCREENS CERTIFIED WITH THE APPLIANCE ONLY

Pour utilisation avec portes de verre and écrans de certifiés avec l'appareil seulement



For Indoor Use Only

*Référez-vous au manuel d'installation pour plus d'information.

LB1224-V1.0-SIT (p) with screen-for-FID-SEP-11-2015

Vented Gas Fireplace Heater		For Indoor Use Only	
Max. Input	Min. Input	Output / Rendement	Orifice Size / Taille D'Orifice
24,000 BTU/H	20,000 BTU/H	18,912 BTU/H	1@ 41 DMS / N/A
23,000	19,000	18,423	1@ 54 DMS / N/A

*Clearance to Combustibles		*Degagements Aux Combustibles	
Sides/Côtés:	Back/Derrière:	Top-Top Vent/Du Haut-Évent Du Haut:	Top-Rear Vent/Du Haut-Évent Arrière:
NC	NC	NC	N/A
NC	NC	N/A	0"
NC	NC	17"	

Do Not Remove This Label
N'enlevez Pas Cette Étiquette

Type: **Vented Gas Fireplace Heater**

Not for use with solid fuel. / Pas pour l'usage avec le combustible solide.

Not for use with air filters. / Pas pour l'usage avec des filtres à air.

Model No. Modèle: 34FID-L-F

Part No: 34FIDNI L-01

Serial No: 2-151006-242120

Manufacturer / Fabricant: Canadian Heating Products Inc., Langley BC, (www.montigo.com)
Montigo DelRay Corp., Ferrdale, WA. (www.montigo.com)

Tested To / Examiné À: CSA/ANSI Z21.88-2019 / CSA2.33-2019

Electrical Rating / Estimation Électrique: 115V / 1Ph / 60Hz /less than 12A

Altitude Rating / Estimation D'Altitude: N & H (0 - 4500 ft. / 0 - 1371 m.)

Fuel Type / Type De Carburant:

Natural Gas / Gaz Naturel

Propane / Gaz Propane

FOR USE WITH GLASS DOORS AND SCREENS CERTIFIED WITH THE APPLIANCE ONLY

Pour utilisation avec portes de verre and écrans de certifiés avec l'appareil seulement

For Indoor Use Only

*Référez-vous au manuel d'installation pour plus d'information.

LB1223-V5.2 SIT (P) -with screen AUG-17-2015

Vented Gas Fireplace Heater		For Indoor Use Only	
Max. Input	Min. Input	Output / Rendement	Orifice Size / Taille D'Orifice
31,000 BTU/H	26,000 BTU/H	23,994 BTU/H	1@ 35 DMS / N/A
30,000	24,000	23,550	1@ 52 DMS / N/A

*Clearance to Combustibles		*Degagements Aux Combustibles	
Sides/Côtés:	Back/Derrière:	Top-Top Vent/Du Haut-Évent Du Haut:	Top-Rear Vent/Du Haut-Évent Arrière:
NC	NC	NC	N/A
NC	NC	N/A	0"
NC	NC	17"	

Figure 1.1 Rating Plate for 34FID Linear

Figure 1.1 Rating Plate for 30FID Traditional

Section 1: Product Dimensions

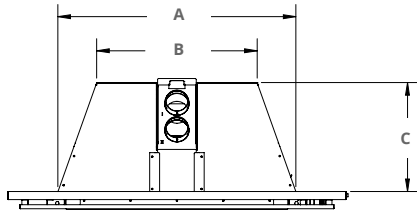

ILLUME STANDARD TRIM DIMENSIONS

	A	B	C	D	E	F	G	H	I	J	K	L	M	N	O
30FID	29½"	19½"	13½"	27¾"	26¼"	26¾"	25¾"	42"	24¼"	19½"	16¾"	14½"	5¾"	20"	13½"
34FID	33½"	23¾"	14½"	31¾"	30¾"	30¾"	29¾"	46½"	28¾"	23¾"	20½"	18½"	5¾"	23¾"	14½"

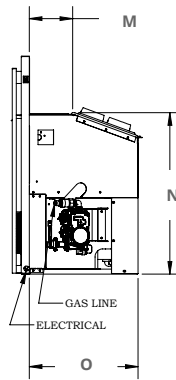
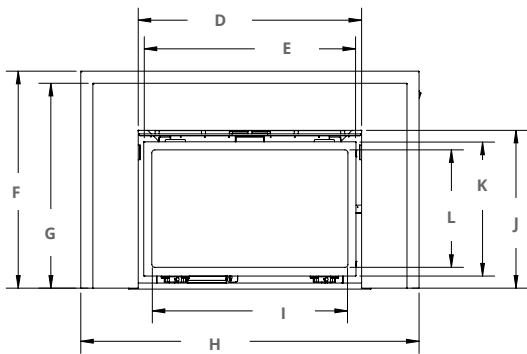
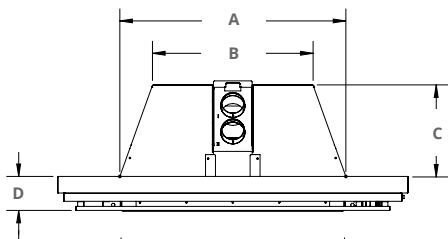

Figure 1.3 Unit dimensions (Tolerance $\pm \frac{1}{8}$ ") [1.25 mm]



ILLUME STANDARD TRIM WITH OFFSET KIT

	A	B	C	D	E	F	G	H	I	J	K	L	M	N	O	P	Q	R
30FID	28"	19¾"	11½"	4¼"	27¾"	26¼"	27¾"	26¾"	25¾"	43½"	42"	39"	24¾"	19½"	16¾"	14½"	3¼"	20"

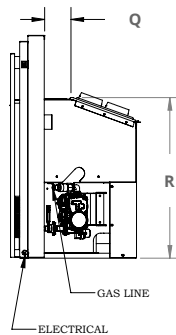
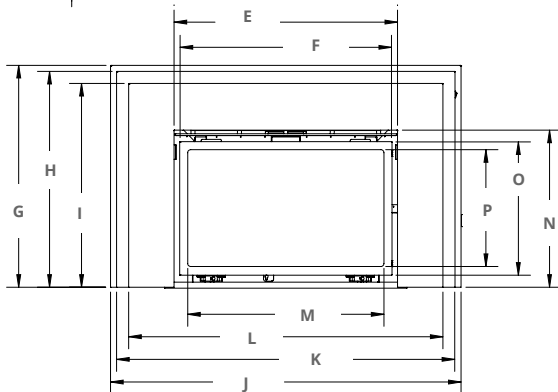
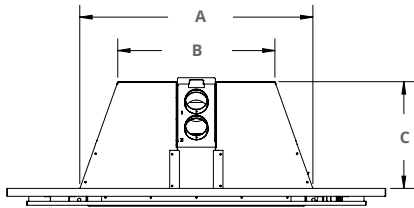

Figure 1.4 Unit dimensions (Tolerance $\pm \frac{1}{8}$ ") [1.25 mm]



ILLUME WITH OVERSIZED TRIM DIMENSIONS

	A	B	C	D	E	F	G	H	I	J	K	L	M	N	O	P
30FID	29½"	19¾"	13½"	27¾"	26¼"	29¾"	27¾"	47¾"	43"	24¼"	19½"	16¾"	14½"	5¾"	20"	13½"
34FID	33½"	23¾"	14½"	31¾"	30¾"	33¾"	32¾"	52"	49"	28¾"	23¼"	20½"	18½"	5¾"	23¾"	14½"

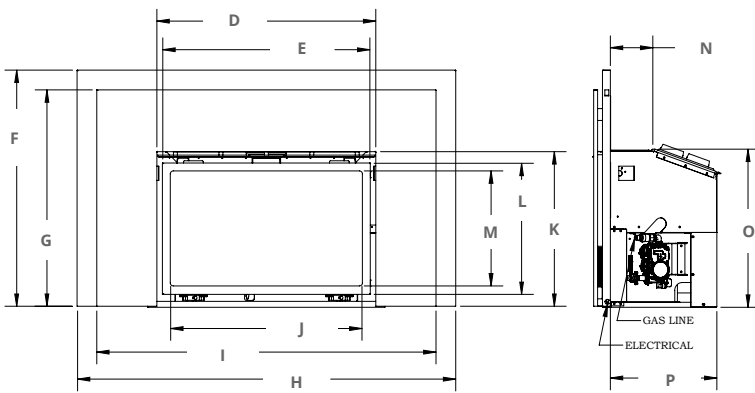
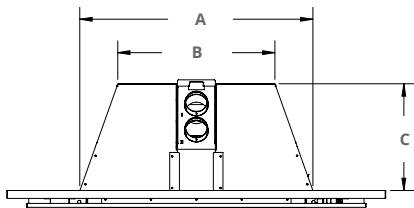

Figure 1.5 Unit dimensions (Tolerance $\pm \frac{1}{8}$ ") [1.25 mm]



ILLUME WITH FOUR SIDED TRIM DIMENSIONS

	A	B	C	D	E	F	G	H	I	J	K	L	M	N	O	P	Q	R
30FID	29½"	19¾"	13½"	27¾"	26¼"	32"	29½"	42"	39"	24¾"	19½"	16¾"	14½"	7¾"	5¼"	5¾"	20"	13½"
34FID	33½"	23¾"	14½"	31¾"	30¾"	36"	33"	46½"	43½"	28¾"	23½"	20½"	18½"	7¾"	5¼"	5¾"	23¾"	14½"

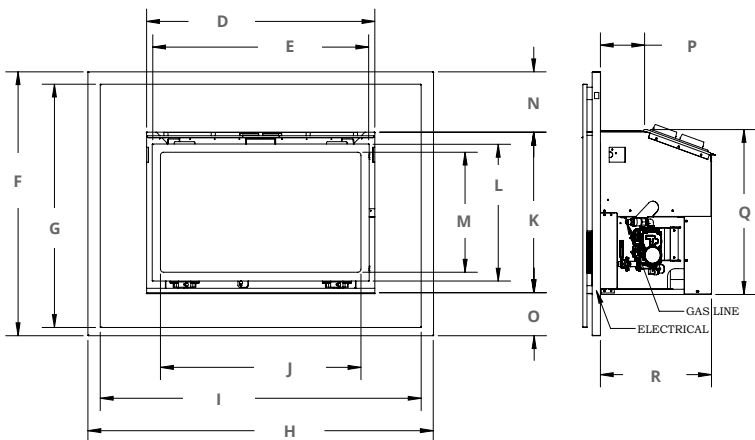

Figure 1.6 Unit dimensions (Tolerance $\pm \frac{1}{8}$ ") [1.25 mm]

Section 2: Installation Dimensions

Before You Begin

The I-Series insert fireplaces must be installed in accordance with these Instructions. Carefully read all the instructions in this manual first. Consult the Local Gas Branch to determine the need for a permit prior to starting the installation. It is the responsibility of the installer to ensure this fireplace is installed in compliance with the manufacturers instructions and all applicable codes.

Installations into a Factory Built Solid Fuel Burning Fireplace

This gas appliance has been tested and approved for installation into any approved masonry or factory built solid fuel fireplace, in which this gas insert will fit.

In the event that the vertical height of the factory built fireplace is less than 20" you may remove some of the components such as the flue baffle, flue damper or surround panels. These components can be removed on the condition that:

- 1). The removal of such components in no way compromises the structural integrity of the unit.
- 2). A label supplied with your insert is prominently affixed to the existing fireplace. This label can be found included in the bag that contains the back-up batteries for the insert.



Install Dimensions

The install size requirements of your fireplace insert are dependent on several factors. Gas line location, electrical connection and gas line type can play into what the minimum installation size can be. The diagram below illustrates the smallest possible size requirement of this model. Please take into consideration these other factors when determining if this appliance will fit into your masonry or manufactured fireplace.

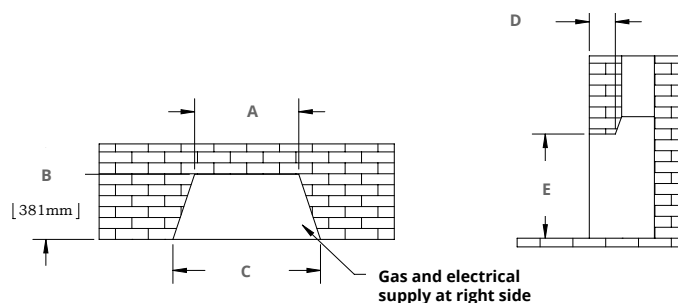

	A	B	C	D	E	F	G	H
30FID	20"	14"	30"	5"	20"	16"	10"	8½"
34FID	24"	15"	34"	6"	24"	23"	10"	8½"

Figure 2.0 Install dimensions

The bottom of the existing fireplace may be removed as long as it does not compromise the structural integrity of the existing fireplace and you maintain a mandatory minimum ¾" clearance between the bottom of the insert and the bottom shell of the existing fireplace. This can be achieved by using strips of noncombustible material or by using the leveling bolts on the insert.

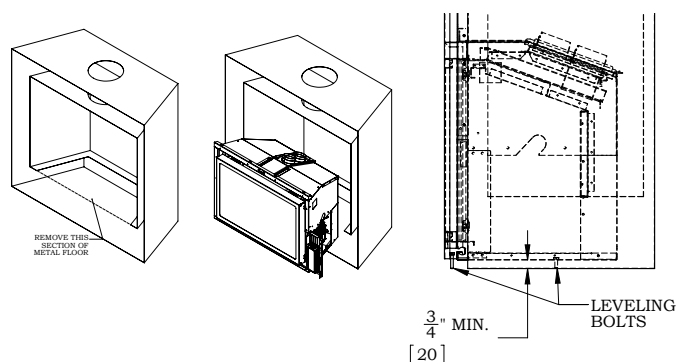

Clearances

The Insert is designed and built to be installed into masonry or manufactured fireplaces. There is no requirement to have a non-combustible hearth in front of the unit. Clearances to the underside of the mantel or sidewall are measured from the edge of the door/screen front. The Mantel is shown as 10" maximum at minimum distance from the door edge top. The mantel can be extended further providing that you increase the height proportionately. For instance, if you want a mantel that is 2" beyond the maximum, you have to install it 2" above the minimum.

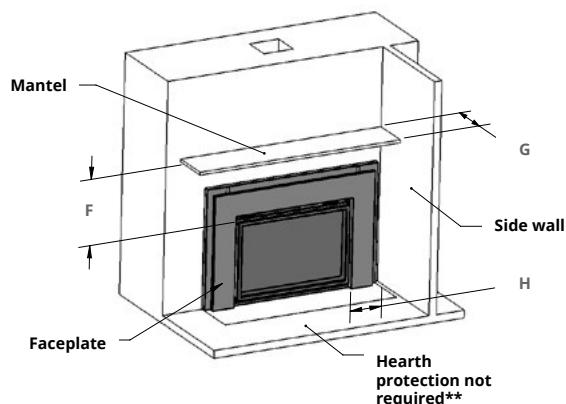

Figure 2.1 Install clearances

**Hearth protection is not required if the unit is installed with a 2" (50.8mm) elevation or greater above the hearth surface. See the section on 4 sided surround options.

Clearances Cont.

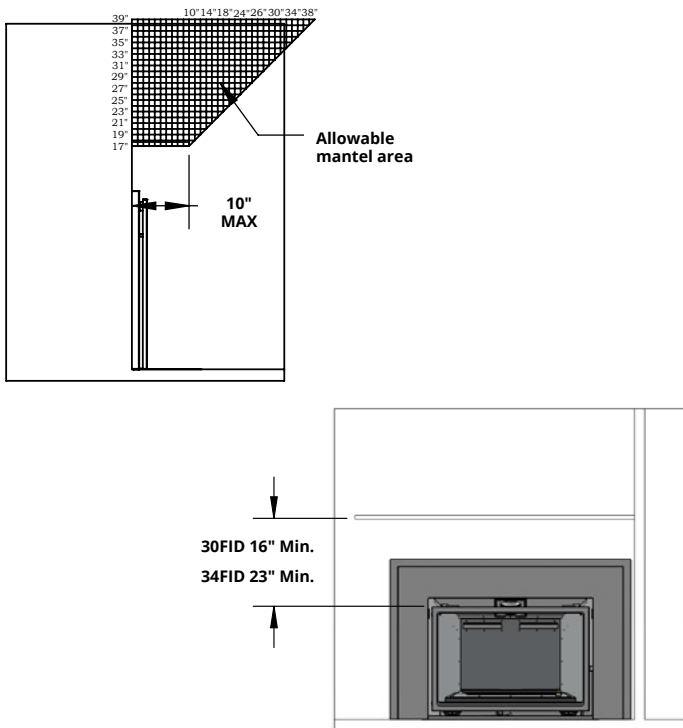

Figure 2.2 Install clearances

Non Combustible Board Install

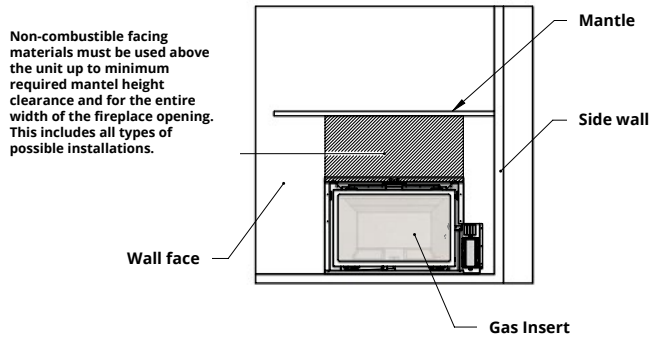

Figure 2.3 Non Combustible Board Install

NOTICE

30FID units use 3"x3" venting. 34FID units use 3"x4" venting

Section 3: Venting

Termination

DuraVent Vertical, High Wind Terminations

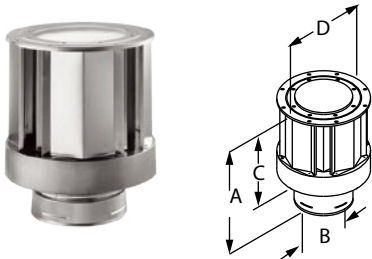

SIZE	ORDER #	STOCK #	A	B	C	D
4" x 6 3/8"	46DVA-VCH	810001359	12 3/8"	6 3/8"	7 3/8"	10 1/2"

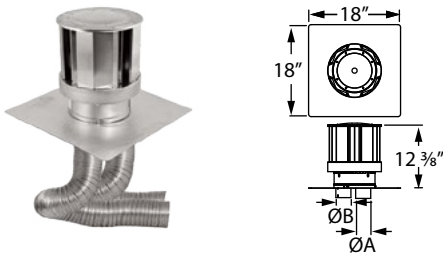

CAP SIZE	ORDER #	STOCK #	A (RED FLEX EXHAUST)	B (AIR INTAKE)	CAP STYLE
4" x 6 3/8"	46DVA-CL33-25	810014029	3" x 25'	3" x 25'	HIGH-WIND
4" x 6 3/8"	46DVA-CL33	810001270	3" x 35'	3" x 35'	HIGH-WIND
4" x 6 3/8"	46DVA-CL34	810001272	4" x 35'	3" x 35'	HIGH-WIND

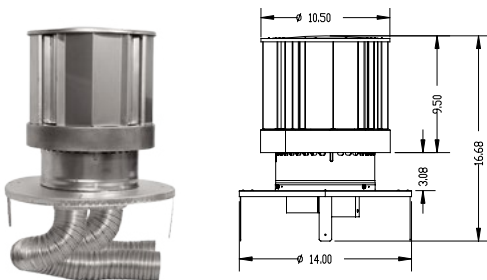

CAP SIZE	ORDER #	STOCK #	A (RED FLEX EXHAUST)	B (AIR INTAKE)	Plate Dimension	CAP STYLE
4" x 6 3/8"	46DVA-CL33KFB	810007970	3" x 35'	3" x 35'	14"	HIGH-WIND
4" x 6 3/8"	46DVA-CL34KFB	810009663	4" x 35'	3" x 35'	14"	HIGH-WIND

Co-linear to Co-axial Adaptor

DuraVent 3" x 3" to 4" x 5 5/8" Co-linear to Co-axial Adaptor
DuraVent 3" x 4" to 4" x 5 5/8" Co-linear to Co-axial Adaptor

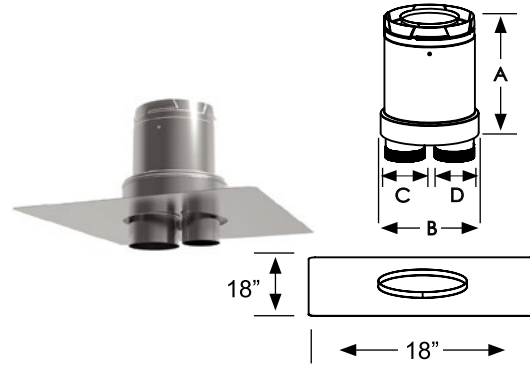

CAP SIZE	ORDER #	STOCK #	EXHAUST	INTAKE	A	B	C	D
4" x 6 3/8"	46DVA-CLTA	810014142	3"	3"	8 7/8"	7 1/8"	3"	3"
4" x 6 3/8"	46DVA-34CLTA	810014340	4"	3"	8 7/8"	8 1/4"	4"	3"

SIZE	ORDER #	STOCK #
4" x 6 3/8"	46DVA-GK	810001269
4" x 6 3/8"	46DVA-CT	810001368

Venting

4" Flex Liner and 3" Flex Liner



SIZE	LENGTH	ORDER #	STOCK #
3"	35'	3DFA-35	810002988
4"	35'	4DFA-35	810002998

MONTIGO FLEX - 35' of 3" aluminum flex, compressed **VT35FL3BC**
MONTIGO FLEX - 35' of 4" aluminum flex, compressed **VT35FL4BC**

Connectors

4DFA-FC, DuraVent 4" Flex Liner Coupling
3DFA-FC, DuraVent 3" Flex Liner Coupling

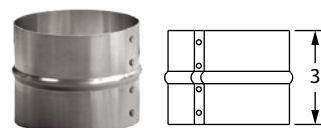

SIZE	ORDER #	STOCK #
3"	3DFA-FC	810002992
4"	4DFA-FC	810003000

Vent Configurations

This appliance can only be vented vertically. The minimum vent height measured from the floor under the unit to the bottom of the termination is 10'. The maximum height that a vent can extend is 36'. The 30FID uses 3" x 3" Co-linear venting, 34FID uses 4" x 3" Co-linear venting. This is a direct vent unit and as such requires that both intake and exhaust vents are connected and operational. Using existing flues as a partial vent mechanism is not allowed. Due care is required to ensure that all vent components are properly connected and sealed. Care must also be taken when installing flashing or termination caps to make sure that the structure of the building cannot be subject to water penetration. Proper roofing and chimney finishing techniques must be used.

Steps for vent connection

** Before installing the venting system, make sure that any dampers or baffle plates in the fireplace are removed or do not present any hindrance to your installation **

- 1). Determine the length of flex venting that will be required. Cut 2 lengths a couple of feet longer than you anticipate needing. The length of these needs to be determined after the vent is stretched out. Flex venting generally comes compressed and needs to be stretched out to meet the lengths as specified.
- 2). From the roof, attach the vent lengths to the adaptor. Don't forget to have the flashing placed between the flex vent and the adaptor before attaching the flex vent.
- 3). Using commercial grade sealant around the perimeter of the Collars of the Adaptor, use a minimum of 3 Tech screws in each Vent.
- 4). Install the Termination to the top of Adaptor. Use a minimum of 4 tek screws to attach the Termination to the Adaptor.
- 5). Feed the flex venting down the chimney until the adaptor is situated near the top of the chimney. Use a commercial grade of sealant between the flashing and the chimney top. Fasten the flashing to the top of the chimney using a fastening method that will properly secure the flashing permanently.
- 6). Attach the adaptor to the top of the flashing using 4 tek screws. Seal around the perimeter of the adaptor where it meets the flashing.
- 7). From inside the house check how long the vents protrude into the fireplace. Read the section on installation where fuel supply pressure checking needs to be done. This procedure can be done at this point by installing the venting to the appliance prior to pushing the appliance into the fireplace cavity.
- 8). Once pre-installation steps have been completed, trim the vent length to the correct length for installation. The correct length will leave the flue collar slide plate suspended around 18-19 inches from the floor of the fireplace.
- 9). Remove the flue collar slide plate from the appliance. Attach both flex ends to the Flue Collar Slide plate. Use a commercial high temp sealant around the Flue Collars on Flue Collar Slide Plate before installing the Venting. Use a minimum of 3 tech screws to properly secure the Venting to the Flue Collar Slide Plate.

** Make certain that the Exhaust and Intake Vents are connected to the correct collars on the Flue Connection Plate. If they are connected in reverse, this unit will not operate and re-installation will be necessary. **

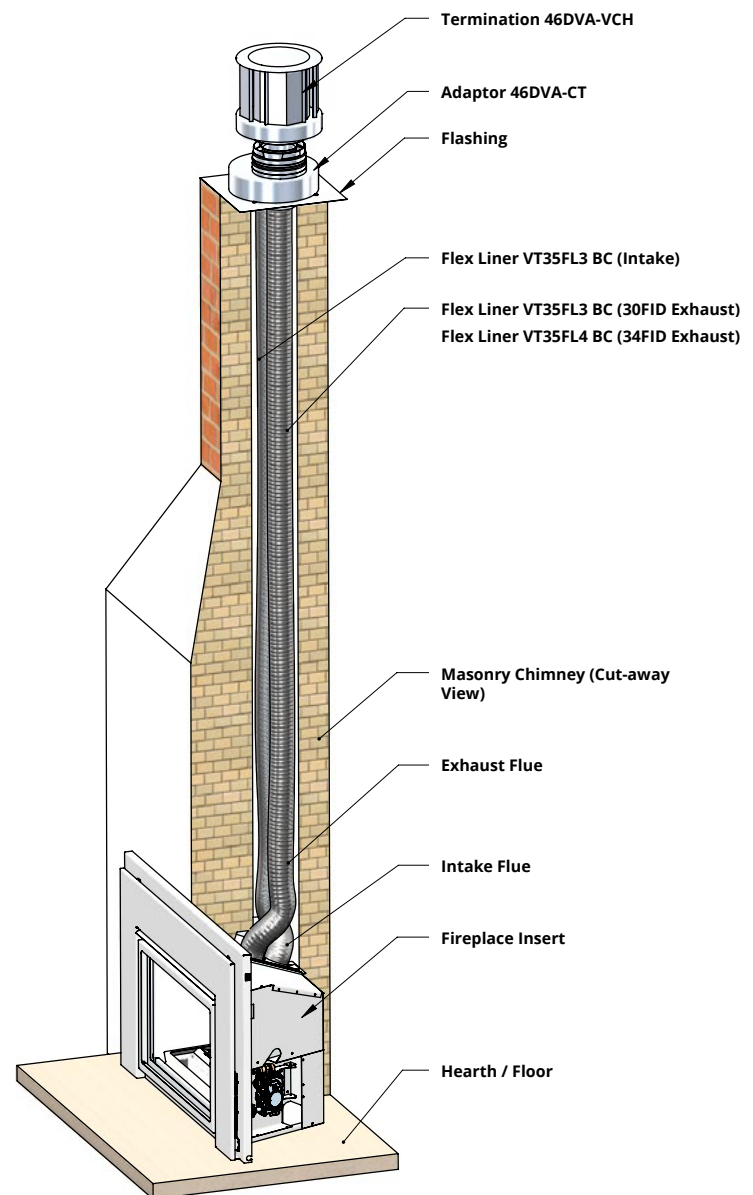

Figure 3.1 Vent Configurations

NOTICE

Example vent system shown, refer to the venting table for other applicable terminations, adaptors, and parts.

- 10). Using the Door Opening Tool provided with the Fireplace Insert, insert the tool through the Outer Shell of the Fireplace Insert. You will be inserting this tool through a keyhole on front edge of the Flue Collar Slide Plate.

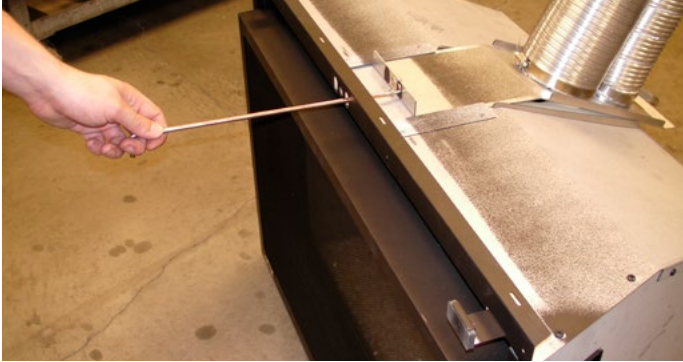

Figure 3.2 Vent Connection

- 11). The Flue Collar Slide Plate needs to be engaged into the Slide Plate Retainers as you pull it forward.

- 12). You will slowly slide the Fireplace Insert back into the Fireplace Cavity. At the same time, you will be pulling the Flue Slide Plate forward onto the Fireplace Insert.

** Be extremely careful that the Gasket between the Fireplace Insert and the Flue Collar Slide Plate is not damaged and remains in the correct position. Failure of this gasket will greatly diminish the operation of this appliance. **

- 13). Make certain that when the Flue Collar Slide Plate comes forward that the tab at the back of the appliance engages into the Flue Collar Slide Plate. Without this engagement, the Flue Collar Slide Plate will not seal against the Gasket and the unit will not function.



Figure 3.2 Vent Slide plate

- 14). Once the Flue Collar Slide Plate is within 1" of the front, Use the 1/4" NC screw supplied and secure the Flue Collar Slide Plate to the front of the Fireplace Insert.



Figure 3.3 Secure Slide plate

Section 3: Installation

Door Installation & Removal

This appliance is supplied with a safety screen installed. The Safety Screen is attached to the fireplace door using 4 screws, and can be removed when necessary for outer glass cleaning.

The Fireplace Door is attached to the Firebox by way of 2 tabs mounted to the top of the Firebox and by 2 spring loaded retainers at the bottom underneath the Door. The Retainers at the bottom of the unit are manipulated using a Door Tool that is supplied with the unit. The general operation of the Door Retainers is:

- Engage the Door Tool into the Door Retainer
- Move the Door Tool to the left to release the Door Retainer
- Move the retainer downward and then back underneath the Door
- Swing the Door outward from the unit and then lift the Door up and over the top Tabs

Engage door tool into door retainer. Push door tool left, disengaging the door retainer from the door.



Engage door tool into door retainer. Pull door tool towards you and push downwards, disengaging the door retainer from the door.

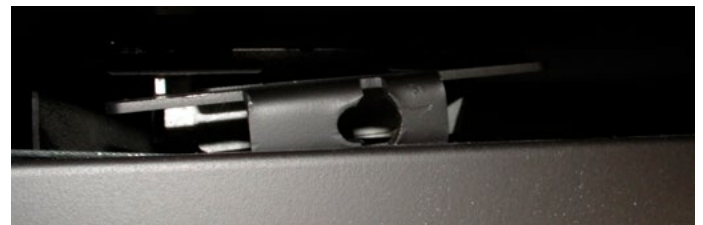
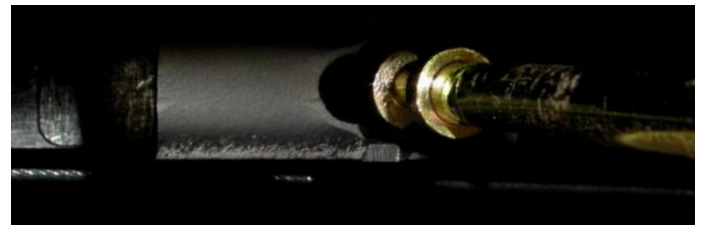
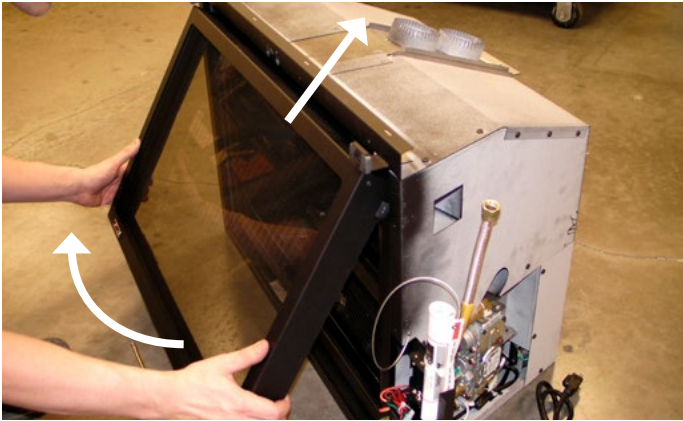

Figure 4.0 Door removal

Swing the Door away from the unit, lift over the retaining tabs on top of the firebox. Be careful to not roll the gasket up off the glass when reinstalling the door. Installation is the reverse of removal.



Check that the door retainers are properly engaged. If they are not the door relief system may not operate properly. This can cause a risk of injury or improper operation of the appliance.

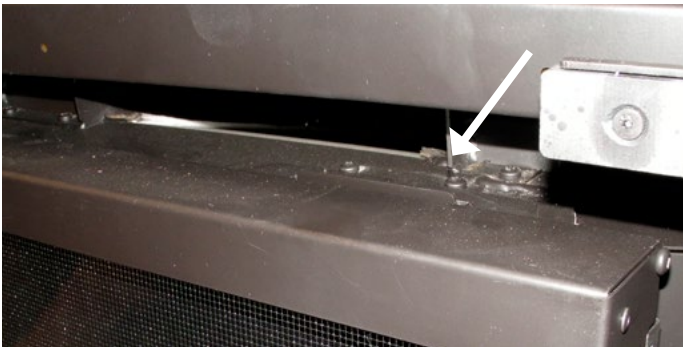

Figure 4.1 Door removal

⚠ WARNING

When installing the fireplace - gas lines, accessories or any other objects cannot impede the proper movement of the door buckles.

Propane Conversion

The unit is available in Natural Gas or Liquid Propane versions. If you have a Natural Gas unit and would like to burn Propane you can purchase an optional Propane conversion kit and install it using the following steps. To convert the unit to Propane, the unit must be disconnected from any gas supply, disconnected from any electrical supply and batteries and removed from any installation cavity.

The 6 major items that need modification to convert a unit to Propane:

1. Variable regulator on the gas valve
2. The main burner orifice
3. The pilot burner orifice
4. Set minimum primary air tab
5. Label on the valve showing the new specifications
6. Gas fitter conversion label



Figure 4.1 Propane conversion kit showing pilot orifice, main burner orifice, Propane stepper motor, zap strap and gas fitter conversion label.

Tools required:

1. Torx T20 Screw Driver Bit
2. 3/8" Socket Driver
3. 5/32" Allen Key
4. Needle Nose Pliers or Small Flat Head Screw Driver

Converting the gas regulator on the valve

1. On the right side (control side) of the unit, remove 2 screws that enable the valve to swing away from the unit.

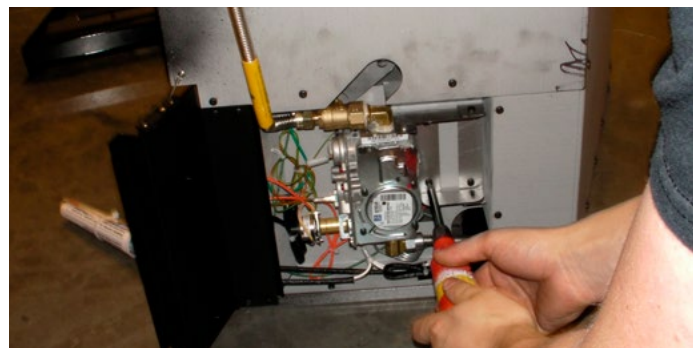

Figure 4.2 Propane conversion kit showing pilot orifice, main burner orifice,

- Swing the valve away from the unit in order to get access to the front of the valve and regulator. Be careful not to damage gas lines or wires.

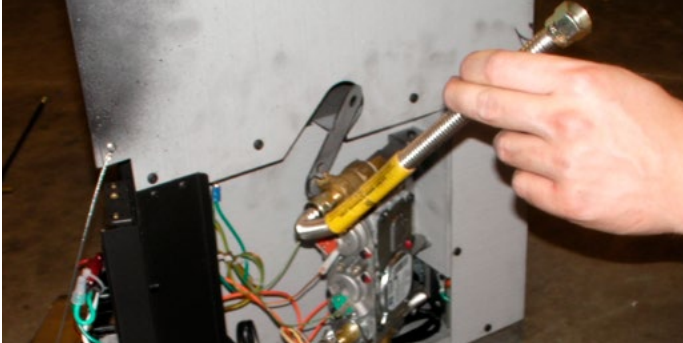

Figure 4.3 Converting the gas regulator on the valve

- Using a T20 Torx screw driver, remove the 2 screws that attach the stepper motor to the valve.

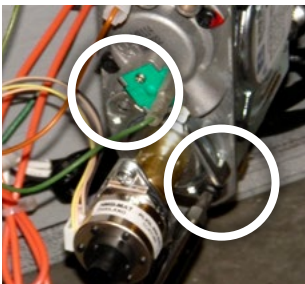

Figure 4.4

- Remove the screws, stepper motor and rubber diaphragm.



Figure 4.5

- Remove the top 2 screws that hold the control mounting bracket in place.



Figure 4.6

- Unplug the cable that runs from the stepper motor to the control board and remove it from in between the control board bracket and the fireplace.



Figure 4.7

- Place the Propane stepper motor onto the valve being extremely careful that the orientation of the regulator is correct.

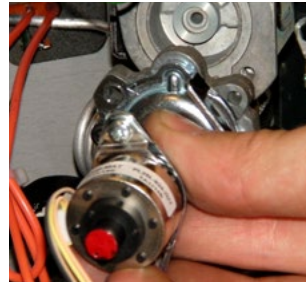

Figure 4.8

- Reinstall the 2 screws supplied with the conversion kit to fasten the stepper motor to the valve body.



Figure 4.9

- Attach the label provided to the side of the valve body.

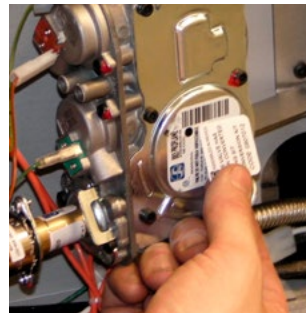

Figure 4.10

- Run the cable from the stepper motor in between the control mounting bracket and fireplace.

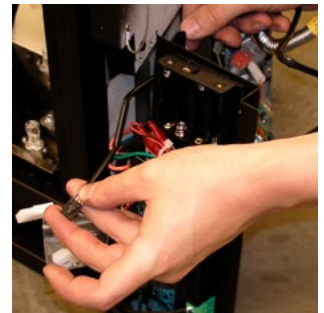

Figure 4.11

- Plug the cable into the control board.



Figure 4.12

- Reinstall the 2 screws to secure the top of the control board mounting bracket. Using the zip strap supplied, secure the excess of wires neatly within the control / valve area. Re-install the 2 screws that keep the valve body from swinging out from the unit. When swinging valve back in use care to not pinch or kink wires or pilot gas line. Inspect pilot gas line for leaks.

Converting the main burner orifice to Propane

13. Remove burner, see burner removal section. Using a socket wrench and driver, loosen and remove the main burner orifice.



Figure 4.12

14. Place the Propane main orifice into the end of the socket wrench. Being sure not to cross thread the orifice, install the orifice into the mounting within the air shutter box.



Figure 4.13

Converting the pilot orifice to Propane

15. Remove the spring clip that retains pilot hood. Remove hood

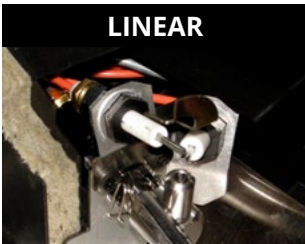

Figure 4.14



Figure 4.14 b

16. Using an Allen key, remove the NG Pilot Orifice

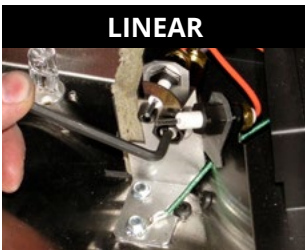

Figure 4.16

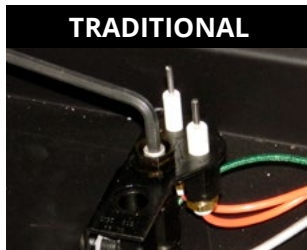

Figure 4.16

17. Replace the NG Pilot orifice with the Propane Pilot orifice. If you get the orifices mixed up, the Propane orifice has a groove machined around the diameter near the end.

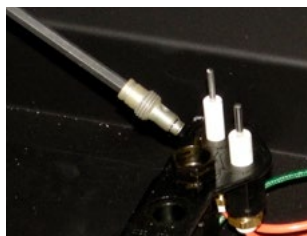

Figure 4.17

19. Reverse steps to install pilot hood.

20. The minimum primary air setting is different depending on fuel and burner. The minimum primary air is set by hand-bent tabs on the primary air adjustment. Bend the appropriate tab down for your fuel and burner. See specifications table or primary air adjustment for proper tab. See image below for tab lengths. If your setting is fully closed, bend both tabs up.

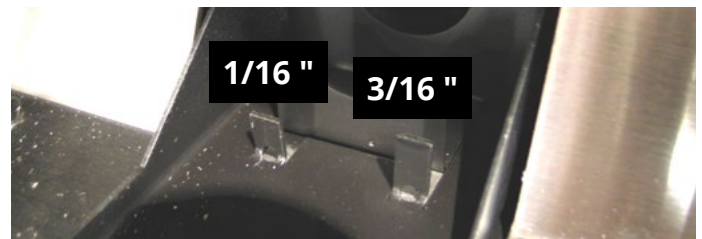

Figure 4.18

21. Connect the unit to the gas and electrical supply.

22. Before concluding the conversion, make sure you leak test the entire system and check all operational functions to ensure that the unit is performing safely and properly.

23. Fill out required information on Propane conversion label.

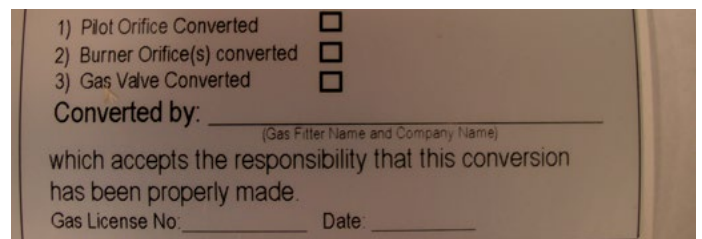

Figure 4.19

24. Remove rating plate from under appliance and turn it over to the blank side.

25. Apply sticker to blank side. Put rating plate back.



Figure 4.20



Figure 4.21

Gas line connection

The Insert is supplied with a flexible gas line that uses a ½" female flare to connect to your service. The flexible gas line is a one time connection. If you ever have to break the connection, you must replace the flexible gas line. There is also a safety shutoff valve that is built in and operated when needed used the door removal tool. Depending on your local gas codes, you may need to provide an additional gas shut off valve or even hard pipe the unit. In the event that you need to hard pipe the gas supply, a union will be required.



Figure 5.0

Emergency Shut-off Valve

This appliance is equipped with a shut-off valve for use in case of emergency. It is located on top of the appliance gas valve and can be accessed and operated through the front of the fireplace using the door tool. The appliance is shipped from the manufacturer with the emergency shut-off valve in the closed position.



Figure 5.1

Hook the door tool into the arm of the emergency shut-off valve. Pull the door tool towards you to open the valve and push it away from you to close the valve.

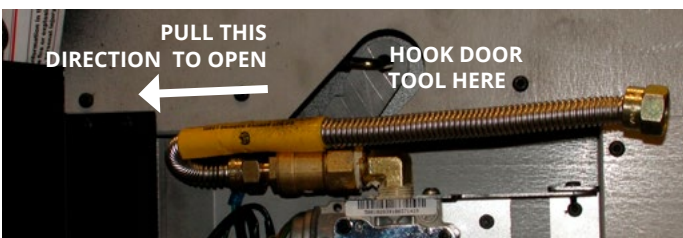

Figure 5.2

Fuel Supply + Manifold Pressure Checking

It's imperative that you verify that the supply pressure to your appliance is adequate and that the valve is supplying the correct pressure to the pilot and main burner. The pilot burner operates at line pressure and may need further adjustment. The valve outlet pressure is set by the manufacturer of the valve but should be verified upon install. Follow the following steps to perform this system check. Inlet pressure must be checked with fireplace burning.

1. Remove the 2 screws from the Valve Mounting Bracket so that the valve can be swung away from the unit. The Shut off lever needs to be in the "off" position to be able to swing the valve out of the valve control box.
2. Using a slotted screw driver, loosen the Manifold Tap on the valve front.

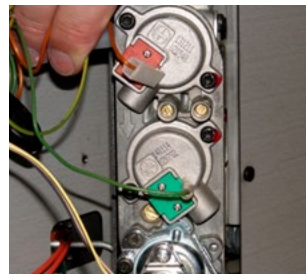

Figure 5.3

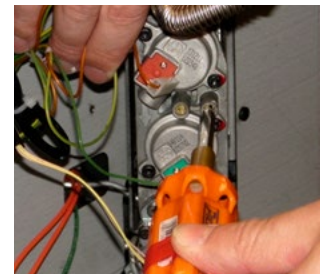

Figure 5.4

3. Attach a silicone hose to over top of the pressure tap on the valve face. Connect the hose to a manometer.



Figure 5.5

4. The emergency Shut-off valve needs to be placed in the "ON" position, see section for operation. The pressure tap on the left is to be used to measure supply line pressure. Refer to the specifications at the beginning of this manual for the gas pressure specs. Be sure to close and leak test all potential leak areas prior to closing in the install. Using the remote, turn the main burner on. Check the inlet pressure and the manifold pressure on high and low. Refer to specification sheet for acceptable values. Remove rubber tubes, close taps and check for leaks. Close emergency shut-off valve reinstall the valve mounting bracket. Make sure wires and pilot gas lines are not pinched or kinked. Check pilot gas line for leaks.

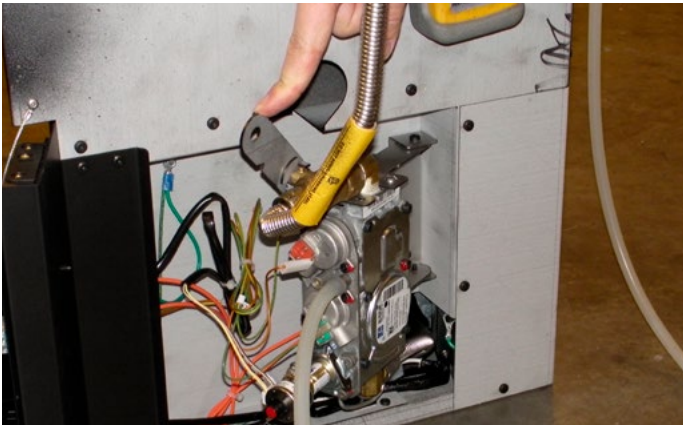

Figure 5.6

Faceplate Installation

The Faceplate Surround has two main parts: the rear panel and the front panel. The rear panel has a master override switch installed on the upper right corner. The rear panel has to be installed prior to the front panel.

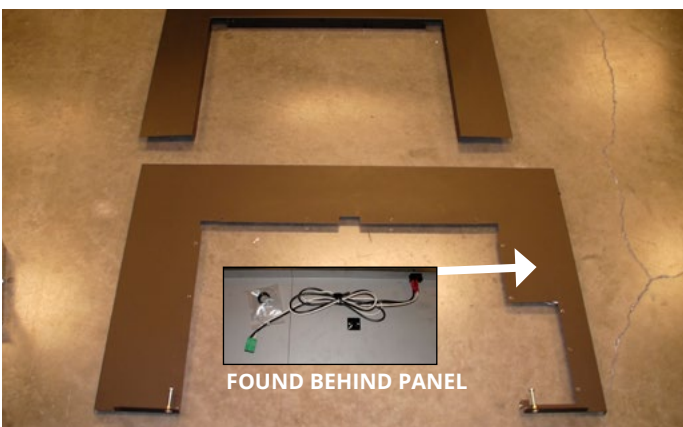

Figure 5.7



Figure 5.8

1. Remove the Lighting Instructions from the Control area and leave on the floor in front of the unit.

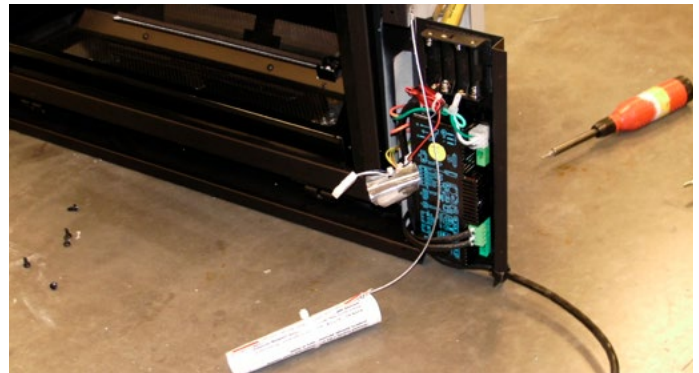

Figure 5.9

2. Install the Rear Faceplate Panel support brackets using screws provided (4 locations). Ensure proper orientation of the bracket.

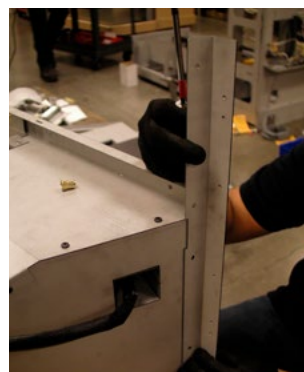

Figure 5.10



Figure 5.11



Figure 5.12

3. Align the Rear Faceplate with the front of the fireplace.



Figure 5.13

4. Temporarily, place the Electrical Cord through the hole in the right side of the Rear Faceplate



Figure 5.14

5. Attach the Rear Faceplate to the Firebox using the screws provided (18 locations). Do not insert screws in magnet locations highlighted.



Figure 5.15

6. Install the four Front Faceplate Retainer Magnets using screws provided as shown (8 locations). Note proper orientation of magnets.

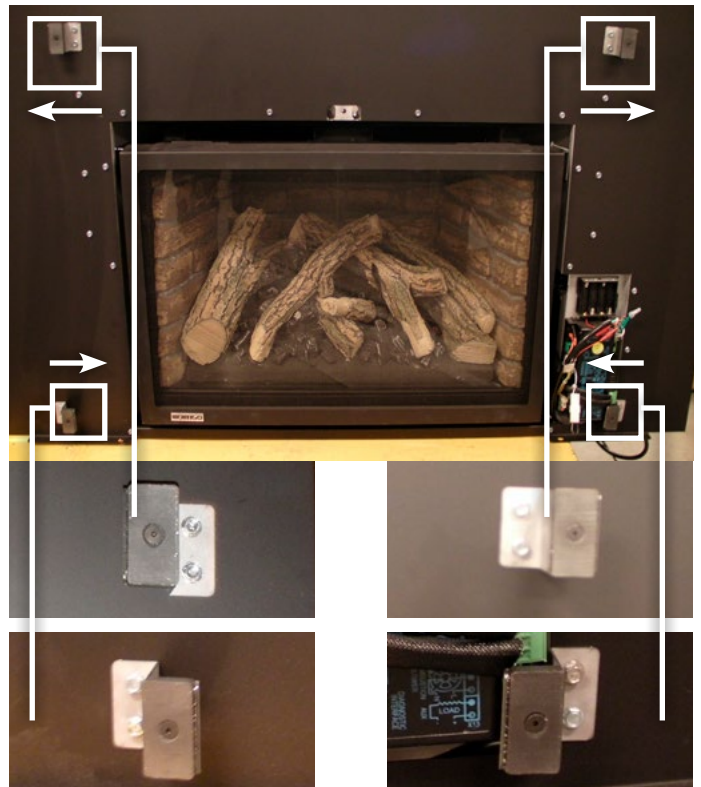

Figure 5.16

- Remove the twist tie and Zap Strap that is on the On / Off Switch wire harness.



Figure 5.17

- Slip the Split Plastic Grommet, found in the plastic bag attached to the master override switch, around the Power Cable and then press it into the provision on the right lower side of the Rear Faceplate to secure the Power Cord.



Figure 5.18

- Thread the On/Off Wire Harness through the gap between the Control Board Mounting Bracket and the Rear Faceplate Panel.



Figure 5.19

- Connect the Plug to the appropriate terminal on the Control Panel.

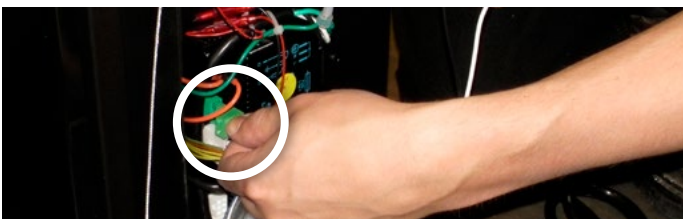

Figure 5.20

- Place the Zip Strap through the hole in the Plastic Stick on Retainer on the back of the Rear Faceplate. Zip the wires together in one tidy package as shown.



Figure 5.21

- Place the master override switch in the OFF position. Until the remote is synced to the control board, this switch acts as a master. If you apply gas and power to the unit while this switch is in the ON position, it will initiate lighting.



Figure 5.22

- At this stage it is easiest to install the batteries. See section on battery installation and replacement.
- The Front trim can now be installed. It has two fasteners at the bottom which must be engaged in the bottom right and left of the Front Faceplate. Magnets hold it at the top right and left.

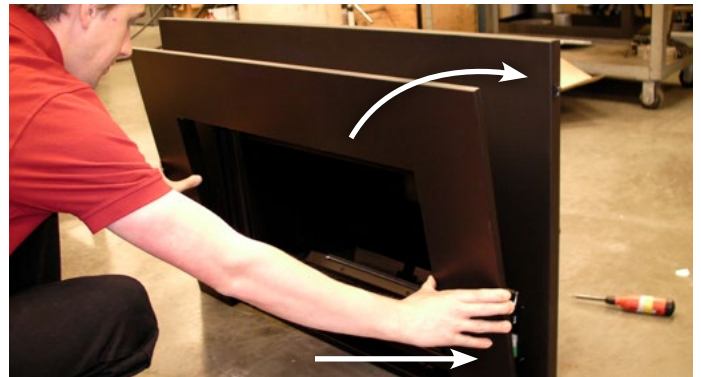

Figure 5.23

- Hooks are used to secure the Front Faceplate at the bottom left and right.



Figure 5.24

- Trim installation completed.



Figure 5.25

Offset Faceplate Installation

When the standard faceplate is used the install width of the fireplace is 30 inches. If your install is smaller than 30 inches, you can use the offset kit, which will allow you to decrease the install size to 28 inches. This can only be done with the standard faceplate kit. You must install the offset kit on the standard faceplate before installing it on the appliance.



Figure 5.12a Standard Faceplate Offset Kit Contents

1. Unpack the standard faceplate kit. Take the rear faceplate and cut 5/16 inches away from the wire pass-through hole at the bottom right hand corner.



Figure 5.12a Cutting away excess material

2. Take the offset faceplate and peel the red protective plastic off of the self-adhesive tape.

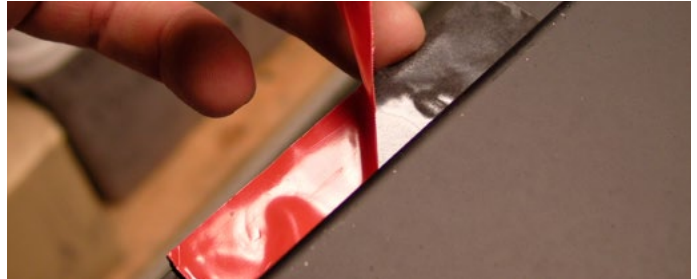

Figure 5.12b Peeling self-adhesive tape

3. Place the rear panel from the standard faceplate over top of the offset trim. Press down on the adhesive to guarantee good adhesion.



Figure 5.12c



Figure 5.12d

4. Continue to standard faceplate installation section for remainder of installation.

POD - Pilot on Demand

What is POD and CPI mode?

This fireplace is equipped with an "On Demand" intermittent pilot ignition system (IPI) which also includes a continuous pilot ignition (CPI) mode with an integrated seven day timer.

In IPI mode, the pilot will light before the main burner, when the appliance is turned on using a wall switch, remote or from a thermostat. Once the appliance is turned off, the main burner and pilot flame will shut down.

The continuous (CPI) mode exists to ease the startup phase in colder climates by keeping the firebox and venting warm when the main burner is not in use. The timer automatically switches off the pilot when the appliance has not been used for seven days.

When the CPI function is turned on, the pilot will remain on after the fireplace is turned off. A timer will then begin the countdown for approximately seven (7) days before shutting off the pilot if the appliance is not used. This countdown will reset anytime the burner is use.

If your appliance is equipped with a remote control device capable of selecting IPI / CPI modes, refer to remote operating instructions.

In order to start your pilot, turning the main burner on with the switch, remote or thermostat and then turning it off will reactivate the continuous pilot mode and reset the seven day timer.

A jumper is supplied with this unit that can be plugged into the wire harness connected to the controller. This jumper cable gives the Remote Control the ability to operate the POD / IPI switch and set the unit to operate in either condition. Please refer to jumper installation instructions for more information.

Remote Continuous Pilot (CPI) Selection

Requires installation of the CPI JUMPER

With the system in "off" position press the Mode Key, to index to the CPI mode icon, Pressing the Up Arrow Key will activate the Continuous Pilot Ignition mode (CPI). Pressing the Down Arrow Key will return to IPI. A single "beep" will confirm the reception of the command.

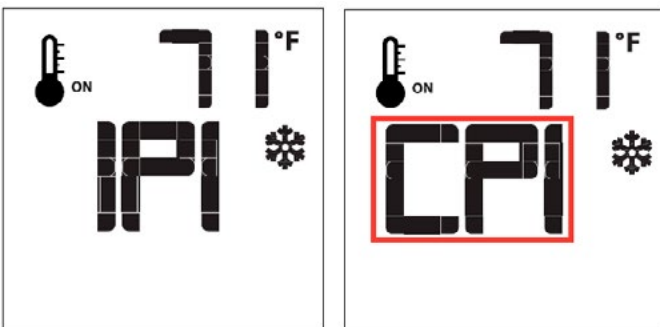

Installing the CPI Jumper Cable

- 1). Access the control box.



Figure 19.a Open the control box drawer

- 2). Remove the bag containing the Jumper Cable from the wire harness connected to the controller.

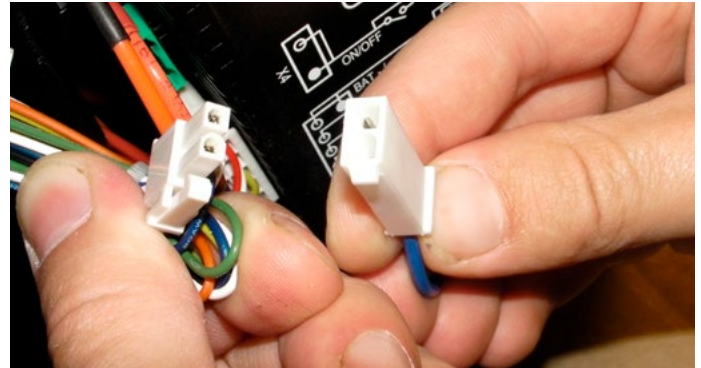

Figure 19.b Locate Jumper cable

- 3). Find the corresponding plug attached to the control wire harness and connect the CPI jumper.

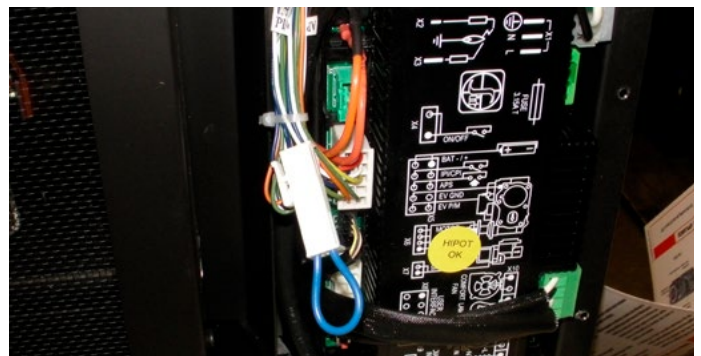

Figure 19.c Connect CPI

- 4). See operation section to turn remote into CPI mode.

Levelling the Unit

This unit has 4 leveling screws, 2 located inside the rear of the firebox and 2 located at the bottom front of the Rear Faceplate. Once the unit is in position, you can use a Phillips screw driver or Slotted screw drivers to adjust each leveling screw as required.

1. Remove burner, see section on burner removal and install
2. Rear leveling screw adjustment (Linear burner version shown)

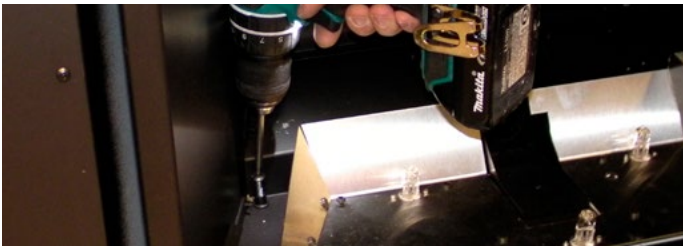

Figure 7.0

3. Front leveling Screw adjustment (Linear burner version shown)



Figure 7.1

4. Reinstall the burner.

Connecting Power

Please refer to the specification for power supply requirements. This appliance is supplied with a Power Cord located on the right side of the appliance. It can be connected directly to a standard electrical outlet.

WARNING

Electrical Grounding Instructions

This appliance is equipped with a three-prong rounding plug for your protection against shock hazard and should be plugged directly into a properly grounded three prong receptacle, Do not cut or remove grounding prong

Battery Installation / Replacement

The unit uses 2 different sets of Batteries. The Control Backup uses 4x AA batteries to continue operations during power outages. The Remote Control uses 3x AAA Batteries for general operation. The Control Backup Batteries should be changed on a regular basis regardless of if they have been used or not so that in the event of a power failure, you will continue to have an operational heating appliance. To replace the Controller Backup Batteries, remove the Front Faceplate and remove and re-install new batteries into the Battery Holder located just above the main Control Board.



Figure 7.2

Firestones or Fireglass Installation

If your fireplace has already been in operation, disconnect the gas and electrical supply, remove the door and safety barrier.

1. Open the 9lbs of glass media purchased from your Montigo Dealer. You only need 8lbs - remove approximately 1lb.
2. Do not drop any glass media into the pilot. To protect the pilot when installing the glass media, place a piece of tape over the pilot opening. Remove tape when media installation is complete and before operating the unit.

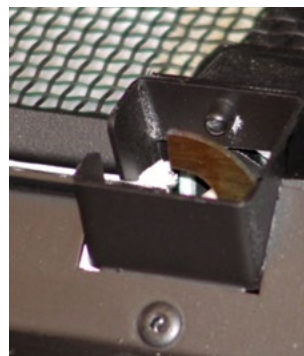

Figure 7.3



Figure 7.4

3. Evenly distribute the glass media around the burner tray. Make sure there is only one layer of glass media covering the burner ports.



Figure 7.5

4. If you used tape to cover the pilot opening, remove it now.
5. Installation is complete.

Speckled Stone Installation

If your fireplace has already been in operation, shut off the gas and electrical supply, remove the door and safety barrier.

The driftwood log and speckled stone option is a beautiful way to dress up your new fireplace insert. Installation of the stones and logs need to be done in a precise way so that the performance of your appliance is not altered. Follow these instructions for years of trouble free operation.

1. You will have 6 bags of speckled stones with your package. Empty the bags of stones into a box and GENTLY mix them up.
2. Place a row of stones front and back of the burner, below the burner lip.



Figure 7.6

3. Fill one layer of stones over the remaining screen/burner area.



Figure 7.8

4. Now carefully place 2 rows of stones along the burner rims so that 1/2 of the stone is sitting on the stones below and 1/2 of the stone is resting on the lip of the burner alternating sides.



Figure 7.9

5. **WARNING:** Figure 7.9 shows that NO stones are placed over the pilot assembly or directly in front of where the pilot flame carries over to the burner. Any exception to this may result in unfavourable lighting of your appliance, or the durability of the pilot and/or burner.



Figure 7.10



Figure 7.11

Driftwood Log Set Installation

Driftwood log set installation images are shown on speckled stones. The driftwood log set can also be installed on glass media.

1. Your driftwood log set has 6 logs and should resemble the image below. Make sure the logs are stable and will not tip or fall.



Figure 7.12

2. Follow the steps below for the placement of the logs.



Figure 7.13



Figure 7.14



Figure 7.15

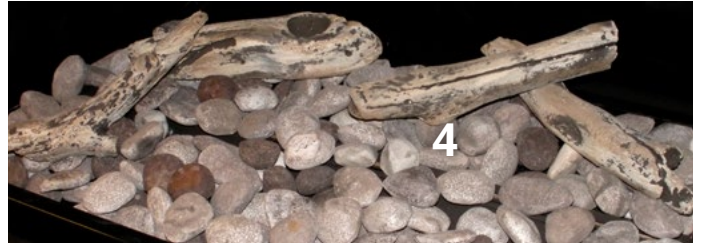

Figure 7.16



Figure 7.17



Figure 7.18



Figure 7.19

Brick Panel Installation

The unit must only be used with the Firebox Panels installed. With the Fireplace Door removed, the panels can be easily installed.

1. Make sure all the Brick Panels are received in good order
2. Slide the side panel along the wall of the Firebox towards the back of the Firebox. There is a retainer clip at the top and at the bottom of the Firebox. These Firebox Panels will slide within them. Leave enough room to slide the rear panel behind the side panel.



Figure 8.0

2. Place the Rear Brick Panel behind the Right Panel.



Figure 8.1

3. Install the Left Brick Panel along the left side of the Firebox.



Figure 8.2

4. Push top retainer in tighter if needed.



Figure 8.4



Figure 8.5



Figure 8.6

Porcelain Panel Installation

The unit must only be used with the Firebox Panels installed. With the Fireplace Door removed, the panels can be easily installed.

1. Make sure all the Porcelain Panels and fasteners are received in good order.
2. The back of the porcelain panels have insulation. Make sure insulation is in good order. Without insulation you may experience pilot stability issues.
3. The porcelain panel kit comes with replacement panel retainers. Use if necessary. See figure 10 Sec.9 for panel retainer location.



Figure 8.7

- Carefully slide the right panel along the right side of the firebox leaving enough room to slide the rear panel behind it. Take care to not scratch the firebox paint.

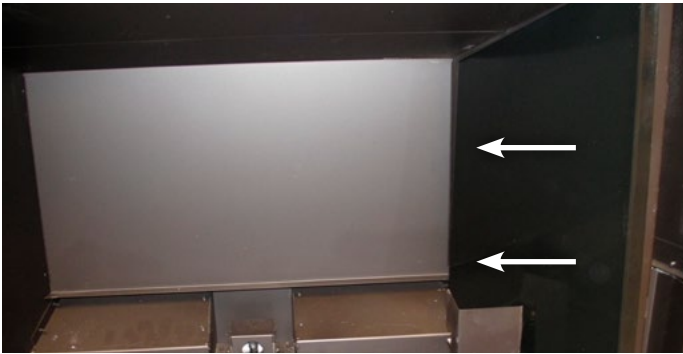

Figure 8.8

- Carefully slide the right panel along the right side of the firebox leaving enough room to slide the rear panel behind it. Take care to not scratch the firebox paint.



Figure 8.9

- There is a securing hole in the bottom of the side panels. Using one of the supplied screws, secure the side panel to the bottom panel retainer. You may need to push the panel back into the firebox to get the holes to line up.
- Slide the left panel into the firebox until it touches the rear panel. Secure with the supplied screw into the bottom panel retainer. If needed, push the top panel retainers in with a screw driver to keep the panels tight against the firebox.



Figure 8.10

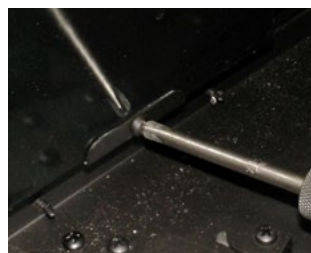

Figure 8.11

34FID Traditional Log Installation

The unit uses high definition cast ceramic logs for exceptional realism. The ceramic is fragile and can easily scuff or chip the logs. The inside of the logs are purple so you want to take care to not damage them. Each log has specific details for correct log placement such as pins, posts or embers to line up with. Follow the images provided to ensure proper operation and flame pattern.

- Inspect the logs as received for any shipping or handling damage.



Figure 8.12

- Take the largest log from the kit and place it on the correct log rest on the left hand side, and locator pin on the right hand side.



Figure 8.13

- Place the second log in the footprint of the log burner outlined below.

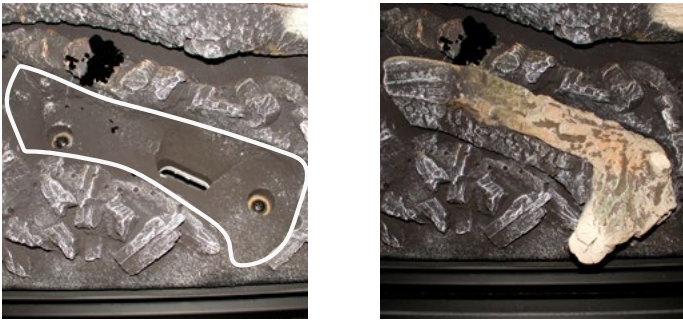

Figure 8.14

- Place the third log on the ceramic burner. The ember part of the log locates on an ember on the burner. The front of the log locates to a groove in the burner.



Figure 8.15

- Place the fourth log on top of the third log and the first log (as shown below). There are two v-shaped notches in Log 4 that match with two v-shaped peaks on Log 1 and Log 3.



Figure 8.16

- Place the fifth log on top of the first log and the fourth log. The first log has a ceramic pin to locate the fifth log. The fifth log locates to an edge on the fourth log.



Figure 8.17

- Place the sixth log on top of the third log and the ceramic burner. The sixth log has a v-shaped notch that matches with a v-shaped peak on Log 3. The end of Log 6 matches up with a cradle in the ceramic burner.



Figure 8.18



Figure 8.19

30FID Traditional Log Installation

The unit uses high definition cast ceramic logs for exceptional realism. The ceramic is fragile and can easily scuff or chip the logs. The inside of the logs are purple so you want to take care to not damage them. Each log has specific details for correct log placement such as pins, posts or embers to line up with. Follow the images provided to ensure proper operation and flame pattern.

1. Inspect the logs as received for any shipping or handling damage.



Figure 8.12b

2. Place black ceramic air baffle on the left side of the firebox. The profile of the burner continues on the ceramic log baffle.



Figure 8.13

3. Place first log on top of the ceramic pin, see Figure 19. Pull first log forward so that it bumps up against the ceramic embers and the ceramic air baffle

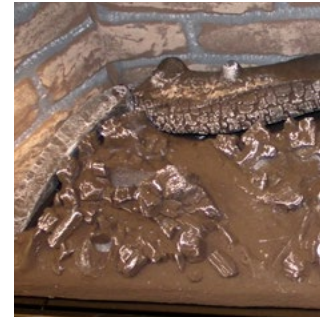

Figure 8.14b

4. Place the second log on top of the first log ceramic pin and fit the front end of the log into the cradle of the ceramic burner



Figure 8.15b

5. Place the third log on the ceramic burner. The ember part of the log locates on an ember on the burner. The front of the log locates to a groove in the burner



Figure 8.16b

6. Place the fourth log on top of the third log. The ember part of the fourth log locates on a 'V' shaped bump on the burner



Figure 8.14c

7. Place the fifth log on top of the first log. The first log has a ceramic pin to locate the fifth log

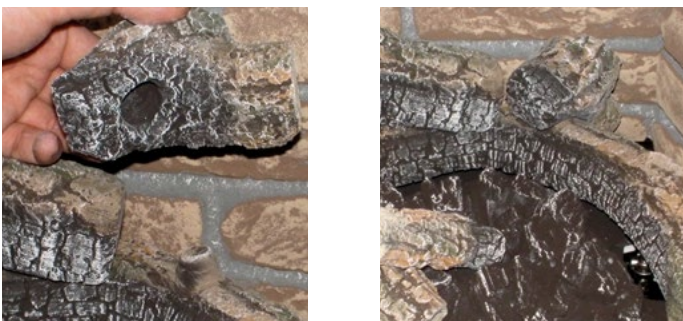

Figure 8.15c

8. Place the sixth log on top of the fifth and first log. The curve in the sixth log meets up with a locator on the first log. The fifth log has a groove in it. Line up the front and sixth log with this groove



Figure 8.16c

9. Place the split end of the 'Y' shaped seventh log on the ceramic burner and place the top end on the second log. Place the other end on the 'Y' on the sixth log



Figure 8.17c

10. Place the end of the eighth log in the ceramic burner. Place the eighth log across the seventh log

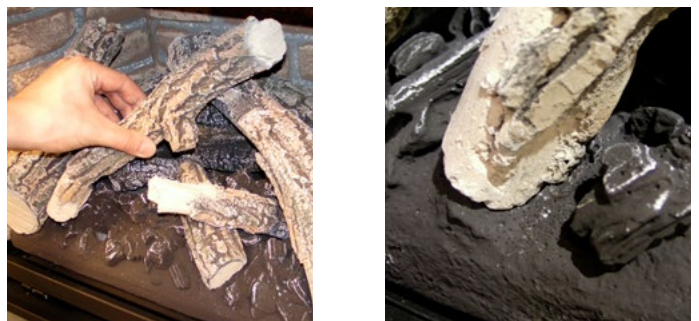

Figure 8.18c



Figure 8.19c

Initial Operation

Your installation and setup is nearly complete. The first fire will result in some smoke and smell being emitted from the appliance. During the manufacturing of the product, paint, sealant and other materials are used and when the unit is fired for the first time, the temperature will cure these materials. When you fire this unit for the first time, make certain that you've opened windows or use any other ventilation to keep these fumes from building up. Once at full operating temperature this will subside and then stop.

Your fireplace comes with decorative ceramic burner, log set and panel set. These items emit gas as part of their curing process. This off gas can sometimes cause initial deposits on the glass. The glass may need to be cleaned after the first few hours of operation. See door removal and glass cleaning section.

Pilot Flame Adjustment

Pilot height is factory set when inlet is 7" WC. Adjustment may be required if installation is not 7" WC. Refer to pilot flame height drawing, Figure 3 Sec. 10. The pilot flame runs directly at line pressure. Variations in supply pressure can affect the size of the pilot flame. Excessive pilot size can overheat the flame proving components. Under-sized pilot flames will result in problems initializing or maintaining the pilot flame or main burner flame, or not carrying over to the main burner as intended. The pilot flame adjustment is on the front of the valve. You need to turn on the fireplace and then using remote control, turn down the flame height until the main burner goes out, leaving only the pilot flame on. If you reduce the pilot flame too much, the unit will go out and then try to re-lite automatically.

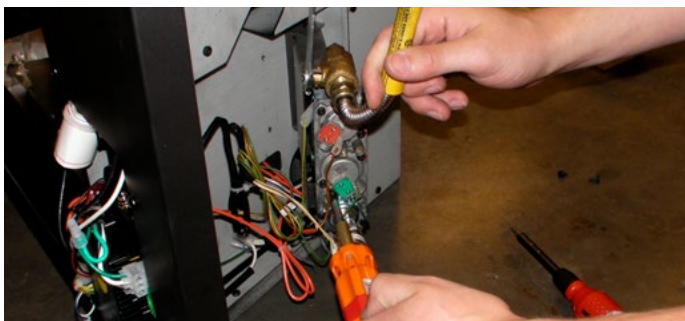

Figure 9.0

Pilot adjustment is made with a flat screw driver turning it in (clockwise) reduces the pilot flame size. Turning it out, (counter clockwise) will increase the flame size. If the pilot is too high the flame at the back right of burner can look too tall.

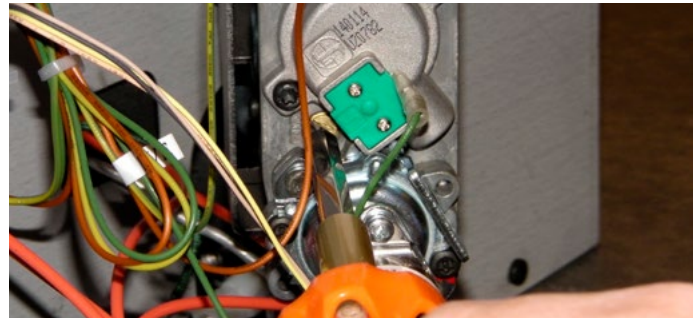

Figure 9.1

If the pilot flame is turned down too much, the flame will lift off the sensor and shut the unit off. The flame should be adjusted until it is not excessively large, but is large enough to operate the unit in a reliable fashion.

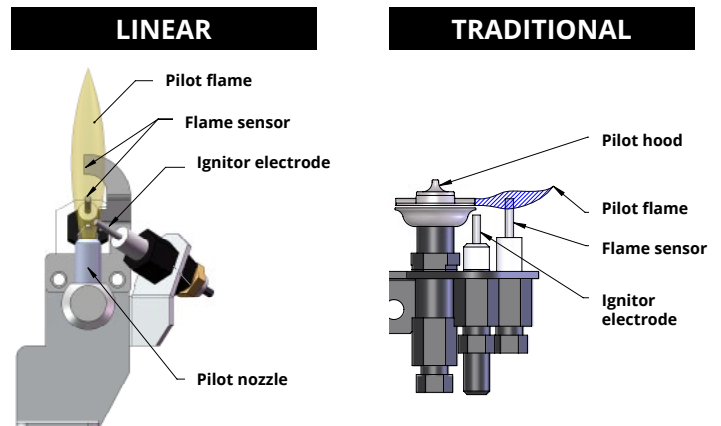

Figure 9.2

Master Override Switch

The on/off switch is located on the top right hand side of the Rear Faceplate. This switch is the master override switch. If it is in the off position the remote cannot turn on the fireplace.



Figure 9.3

FOR YOUR SAFETY - READ BEFORE LIGHTING:



DANGER



HOT GLASS WILL CAUSE BURNS. DO NOT TOUCH GLASS UNTIL COOLED.
NEVER ALLOW CHILDREN TO TOUCH GLASS.

A barrier designed to reduce the risk of burns from the hot viewing glass is provided with this appliance and must be installed for the protection of children and other at-risk individuals.

WARNING: If the information in these instructions is not followed exactly, a fire or explosion may result causing property damage, personal injury or death.

WARNING/ CAUTION: Hot while in operation. Do not touch. Severe burns may result. Keep children, clothing, furniture, gasoline and other liquids having flammable vapours away.

See installation and operating instructions accompanying this appliance for more information.

- A. This appliance is equipped with an ignition system that lights the pilot burner automatically. **Do not attempt to light the pilot by hand.**
- B. **BEFORE LIGHTING** smell all around the appliance area for gas. Be sure to smell next to the floor because some gas is heavier than air and will settle on the floor.
What To Do If You Smell Gas:
 - Do not try to light any appliance.
 - Do not touch any electrical switch; do not use any phone in your building.
 - Immediately call your gas supplier from a neighbour's phone. Follow the gas supplier's instructions.
 - If you cannot reach your gas supplier, call the Fire Department.
- C. Use only your hand to operate gas control. Never use tools. If the control does not function, don't try to repair it, call a qualified service technician. Force or attempt to repair may result in a fire or explosion.
- D. Do not use this appliance if any part has been under water. Immediately call a qualified service technician to inspect the appliance and to replace any part of the control system, and any gas control which has been under water.

LIGHTING INSTRUCTIONS:

1. **STOP!** Read the safety information above on this label.
2. Turn "ON" manual "ON/OFF" switch. (If available)
3. Turn Incoming gas shut off valve to the "ON" position.
4. Wait 5 minutes to clear out any gas. If you smell gas, **STOP!** Follow "B" in the safety information above on this label. If you don't smell gas, go to the next step.
5. Turn fireplace "ON" using wall switch or remote control.
6. If the Fireplace does not light, the System will cycle through two trials, (one minute audible clicking, thirty seconds of silence, and then another one minute of audible clicking). If the system locks out due to inadequate gas flow, refer to "Troubleshooting" in instruction guide.
7. After completion of the information in the Troubleshooting section, Repeat step 5.
8. If the system will not function correctly, follow the instructions "To Turn Off Gas To Appliance" and call your service technician or gas supplier.

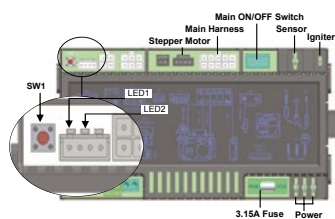

SW1 = Programming Button
 LED1 = Red Diagnostic Light
 LED2 = Amber Programming Remote Control Light
 Typical Control Module shown

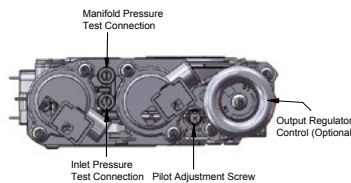

Gas Valve

TO TURN OFF GAS TO APPLIANCE:

1. Turn off fireplace using wall switch or remote control.
2. Turn the incoming gas shut off valve to "Off".

P/N LB1176-000614

Aeration Adjustment

All gas fireplaces mix a certain amount of air with the fuel prior to combustion. This is known as an "Aeration" setting. This is adjustable and needs to be set based on various factors such as:

- 1). Type of fuel
- 2). Altitude of installation
- 3). Type of burner
- 4). Home owners preference to blue or yellow flames.

The unit has an externally adjustable aeration setting, which means it can be adjusted during operation. The minimum air aeration setting is factory set but may need adjustment in the field. Fireplaces need approximately 45 minutes to get up to temperature. Aeration settings should only be made when the unit is at full operating temperature.

The aeration setting lever can be accessed using the Door Tool that comes with the unit. The aeration setting lever is located underneath the firebox, at about the middle of the unit. Pulling the lever forward increases the aeration setting and pushing rearward decreases the aeration setting. The ideal setting will result in a flame that is about 2/3 blue and 1/3 yellow. If you have a burner that is sooting or have soot deposits on your logs or glass, the aeration setting is too small and should be set larger.

Engage the door tool into the keyhole in the Aeration Setting Lever



Figure 9.5

Minimum Aeration Setting

30FID NG - 1/16" Open	34FID NG - 1/16" Open
30FID Propane- 3/16" Open	34FID Propane- 3/16" Open



Figure 9.6

Section 5: Wiring

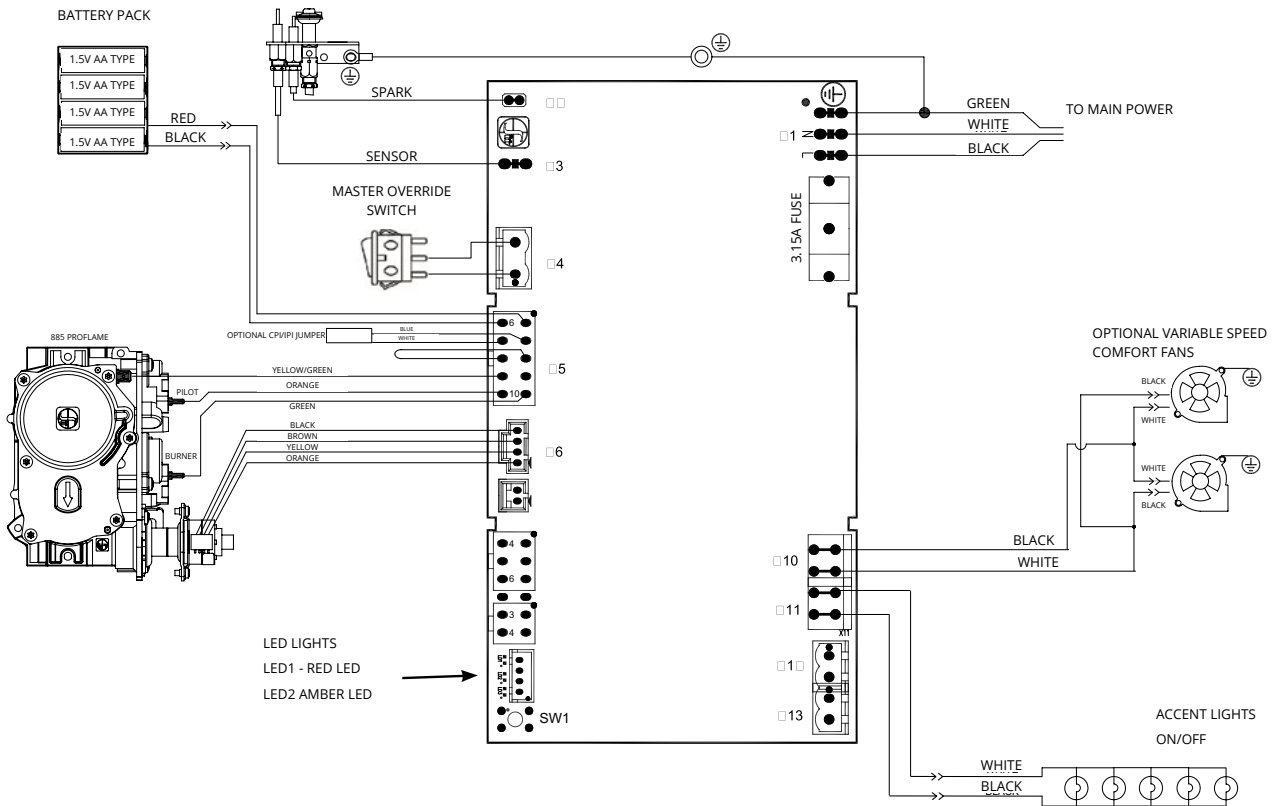

Figure 9.7 SIT Profleme 2 Electronic Ignition

Remote Operation

The Proflame 2 System consists of the following elements:

1. Pilot Assembly
2. Proflame Gas Valve.
3. Proflame 2 Control Module
4. Wiring Harness
5. Variable Speed fans (If applicable)
7. Proflame 2 remote control
8. Battery Pack
- 9 Manual override switch

NOTE: Can not be used with home automation systems.

The Proflame 2 Transmitter controls the following fireplace functions

(all functions may not be available):

1. Main Burner On/Off
2. Main Burner flame modulation (6 levels).
3. Choice of standing or intermittent pilot (CPI/IPI).
4. Thermostat and Smart thermostat functions.
6. Fan speed modulation (6 levels).

The Proflame 2 Transmitter uses a streamlined design with a simple button layout and informative LCD display. A Mode Key is provided to index between the features and a Thermostat Key is used to turn On/Off or index through Thermostat functions, see Figure 27. Additionally, a Key Lock feature is provided.



Figure 9.8 Proflame 2 Remote

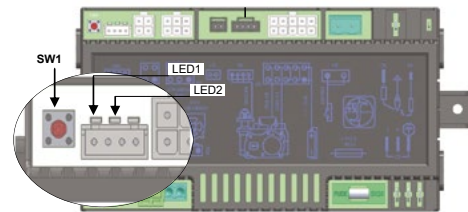

SW1 = Programming Button

LED1 = Red Diagnostic Light

LED2 = Amber Programming Remote Control Light

Figure 9.9 Proflame 2 Control Module

⚠ WARNING

Do not expose remote control to temperatures below 0°C (32°F) or above 50°C (122°F)

⚠ CAUTION

Property Damage Hazard. Excessive heat can cause property damage.
The appliance can stay lit for many hours. Turn off the appliance if it is not going to be attended for any length of time.

⚠ WARNING

Battery operated device. Read the battery instructions before installing them into the system. Do not expose any battery, or its holder, or a device in which batteries are installed, to a working temperature greater than 54°C / 129°F

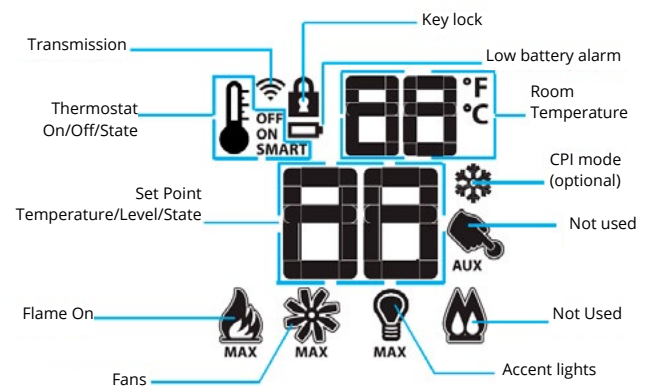

Figure 9.10 Remote Control LCD Display

Initializing the System for the first time

1. Set master override switch to off position.
2. Install four (4) AA batteries into the battery holder.
3. Install three (3) AAA batteries in the back of the remote control. Note the polarity of batteries and install them as indicated by the silk screen (+/-) on the holder.
4. Connect AC Power (115 volts, 60 Hz) to fireplace.

Operating the System for the first time

Press SW1 button on the control module. The control module will beep three (3) times and an amber LED is illuminated to indicate that the IFC (control board) is ready to synchronize with a remote control within 10 sec. Push the ON button. The control module will "beep" four (4) times to indicate transmitter's command is accepted.

The System is now initialized.

Continuous Pilot (CPI) Selection (Optional)

In cold weather climates, the pilot burner can stay on continuously to prevent condensation or cold air temperatures near the fireplace glass. Note, some jurisdictions do not permit use of continuous pilot system. Check local codes or contact your Montigo dealer.

With the system in "off" position press the Mode Key, see Figure 8 Sec.10, to index to the CPI mode icon, see Figure 22 Sec.10. Pressing the Up Arrow Key will activate the Continuous Pilot Ignition mode (CPI). Pressing the Down Arrow Key will return to IPI. A single "beep" will confirm the reception of the command.

NOTE:

- Requires CPI/IPI jumper cable installed

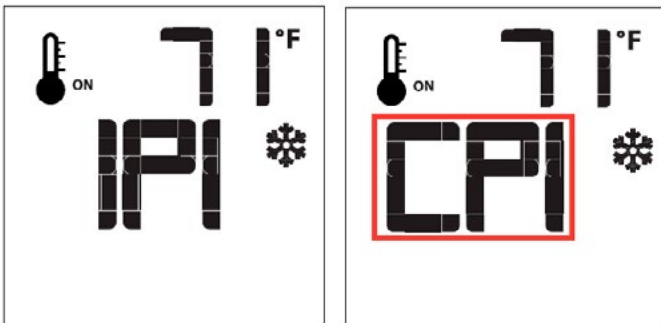

Figure 9.12a Continuous Pilot / Intermittent Pilot Selection

Temperature Indication Display

With the system in the "Off" position, press the Thermostat Key and the Mode Key at the same time. Look at the LCD screen on the Remote Control to verify that a C or F is visible to the right of the Room Temperature display.

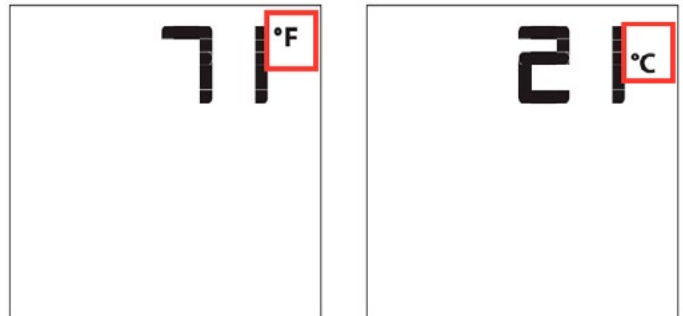

Figure 9.12 Remote Control display in Fahrenheit & Celsius

Turn On the Fireplace

With the system Off, turn the master override switch to on and press the On/Off Key on the Remote Control. The Remote Control display will show some other active Icons on the screen. At the same time the Control Module will activate the fireplace. A single "beep" from the Control Module will confirm reception of the command.

Turn Off the Fireplace

With the system On, press the On/Off Key on the Remote Control. The Remote Control LCD display will only show the room temperature. At the same time the Control Module will turn off the fireplace. A single "beep" from the Receiver confirms reception of the command.



Figure 9.13 Remote Control Display

Remote-Flame Control

When you turn on the fireplace it starts on high. The proflame 2 has six (6) flame levels. Each time you press the Down Arrow Key once the flame height will reduce by one step.

You can continue this until the main burner flame turns off. You can still operate the accent lights and fans in this mode.

If the main burner flame is off and you press the up arrow key once, the flame will automatically go to high.

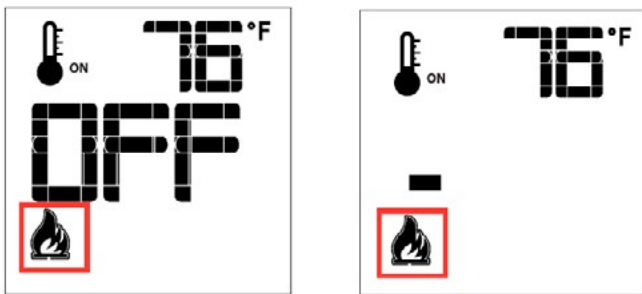

Figure 9.14 Flame Off and Flame Level 1.

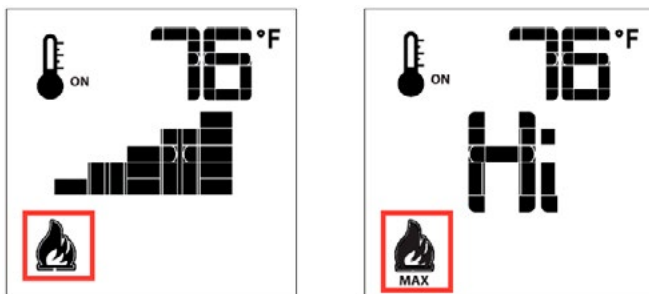

Figure 9.15 Flame Level 5 and Flame Level Maximum

Room Thermostat (Remote Control Operation)

The Remote Control can operate as a room thermostat. The thermostat can be set to a desired temperature to control the comfort level in a room. To activate the function, press the Thermostat Key, see Figure 27i. The LCD display on the remote control will change to show that the room thermostat is "On" and the set temperature is now displayed. To adjust the set temperature press the Up or Down Arrow Keys until the desired set temperature is displayed on the LCD screen of the Transmitter.

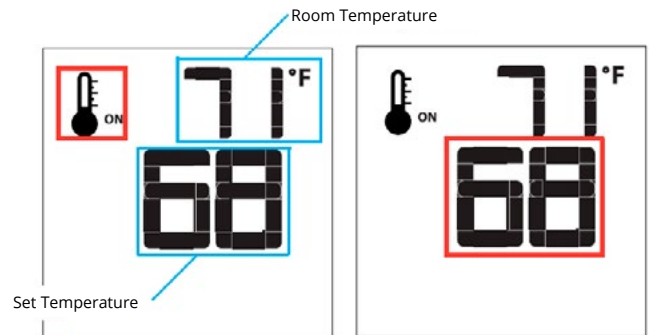

Figure 9.16 Setting Room Thermostat

Smart Thermostat (Remote Control Operation)

The Smart Thermostat function adjusts the flame height in accordance to the difference between the set point temperature and the actual room temperatures. As the room temperature gets closer to the set point the Smart Function will modulate the flame down. To activate the function, press the Thermostat Key, see Figure 27.j, until the word "SMART" appears to the right of the temperature bulb graphic, see Figure 27j.

NOTE: When smart Thermostat is activated, manual flame height adjustment is disabled.

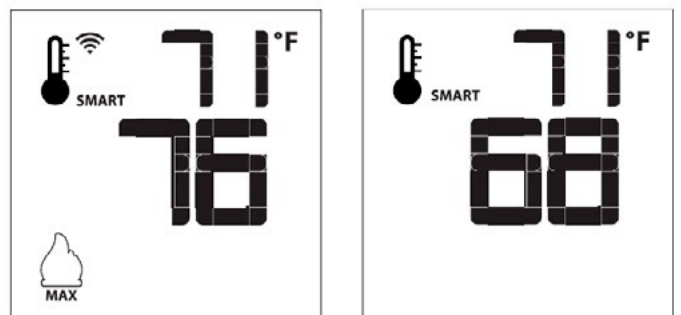

Figure 9.17 Smart flame function

Disabling Thermostat

Some jurisdictions and bedroom installations require the thermostat to be disabled.

1. Partially take out one battery, see Figure 27k.
2. Insert the battery while holding down the thermostat button. The remote screen will display 'Clr' while the button is held down. See Figure 27l.
3. To enable thermostat repeat steps 1-2. The remote screen will display 'set' while the thermostat button is held down.



Figure 9.18



Figure 9.19

Key Lock

This function will lock the keys to avoid unsupervised operation. To activate this function, press the Mode and Up Keys at the same time. To de-activate this function, press the Mode and Up Keys at the same time.

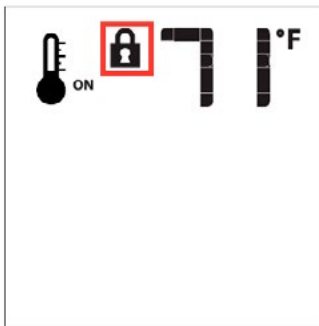

Figure 9.20a Key Lock

Fan Speed Control

The fireplace is equipped with optional hot air circulating fans. The speed of the fans can be controlled by the Proflame system. The fan speed can be adjusted through six (6) speeds. To activate this function use the Mode Key, see Figure 27, to index to the fan control icon, see Figure 27m. Use the Up/Down Arrow Keys to turn on, off, or adjust the fan speed. A single "beep" will confirm reception of the command.

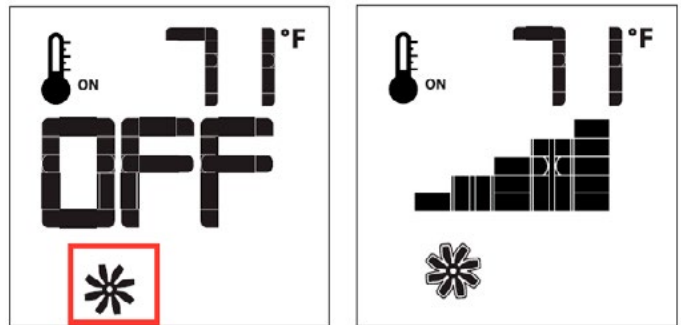

Figure 9.20 Fan Speed Control

Accent Light Control

The fireplace is equipped with variable accent lights. The accent light function controls the Accent Lights. To activate this function use the Mode Key, see Figure 8 Sec.10, to index to the accent light icon.

Pressing the Up Arrow Key will turn the light on at the lowest setting. Continue pressing up to get brighter. Pressing the Down Arrow Key will turn the lights down until you get to the off position. A single beep will confirm the reception of the command.

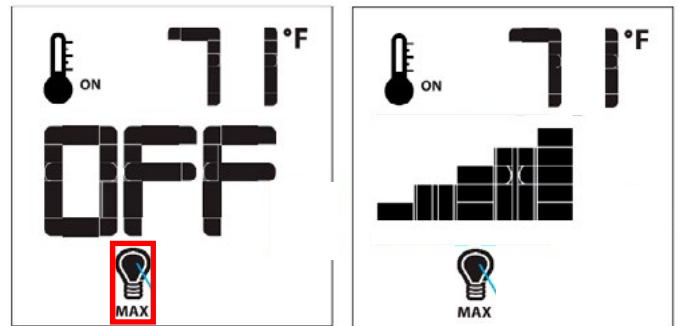

Figure 9.21 Light Control

Section 6: Maintenance

Burner Removal (Linear)

The unit is shipped from the factory with the burner installed. Should it need to be removed for fuel conversion or some other service requirement, follow these steps.

1. The burner assembly can be removed with or without the glass media on top of it. If you have the driftwood log set installed, it needs to be removed first.
2. Remove 2 screws that secure the burner assembly. They are located on either side of the burner assembly near the front of the fireplace.



Figure 9.22

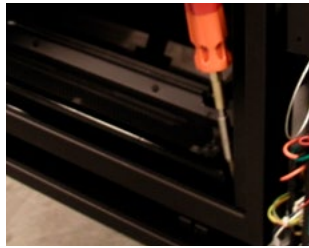

Figure 9.23

3. Lift the front of the burner assembly up over the bottom lip of the firebox. Pull the burner assembly towards you to disengage the mixing tube from the rear burner support.



Figure 9.24

Burner Installation (Linear)

1. At the rear of the burner is the mixing tube. This mixing tube needs to be inserted into the rear burner support.
2. At the back of the firebox you will see the rear burner support bracket. This is where the mixing tube is inserted



Figure 9.25

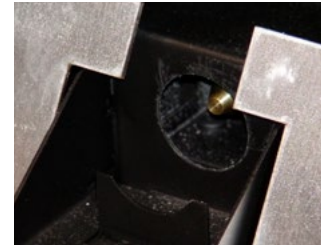

Figure 9.26

3. When installing the burner into the fireplace, angle the burner at the rear to insert the mixing tube into the rear burner support.

** Be careful not to knock or damage the pilot assembly during this installation. **

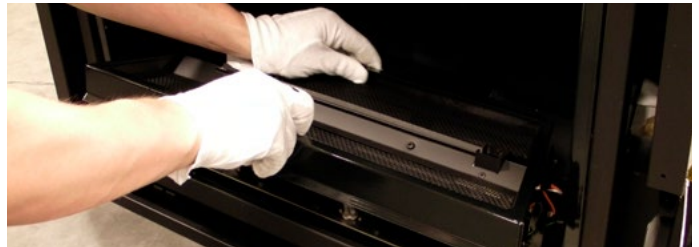

Figure 9.27

4. Once this has happened, the 2 screws can be installed at the front of the burner assembly to fasten the burner assembly into the firebox. The screws will not line up with the holes if the mixing tube is not inserted properly.

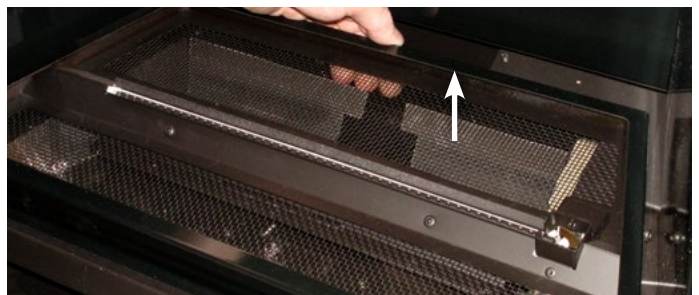

Figure 9.28

Burner Removal (Traditional)

Your new fireplace is shipped with the burner installed. Periodically, the burner needs to be cleaned and inspected or perhaps if the pilot needs service or the unit is to be converted to Propane, you will need to remove and/or re-install the burner. The burner is mounted to the fireplace in 3 places. At the rear of the burner is the Mixing Tube. At the front are two small tabs which fit through a slot and are bent to keep the Burner secure.

The Burner is a cast ceramic material. It is easily chipped or scratched.

Take due care not to damage the Pilot Assembly. The Burner has to be lifted over the Pilot in either case and contact with the Pilot should be avoided.



Figure 9.25b



Figure 9.26b

1. Using a small screw driver or pliers, bend the tabs straight so that they will fit through the slots when the burner is removed.



Figure 9.23b

2. By grasping the burner at either side (if the Firebox Panels are both removed) or at the front and rear, first lift the front of the Burner up about 1-2 inches. Then pull the Burner towards you to remove the Mixing Tube from the Rear Burner Support. Lift the Burner out of the Firebox.



Figure 9.24b

Burner Installation (Traditional)

1. By grasping the burner with both hands, angle the burner into the rear of the firebox to engage the Mixing Tube into the Burner Support Bracket. The Mixing Tube goes into the Burner Support Bracket. If it does not go into the Burner Support Bracket, you will not get the burner to line up at the front and the burner may not operate correctly.
2. Once you have the Mixing Tube situated into the Rear Burner Support, lower the front of the Burner over the Front Burner Supports. Using the same small screw driver or pliers, bent the tabs just enough that the burner cannot be moved from its position.

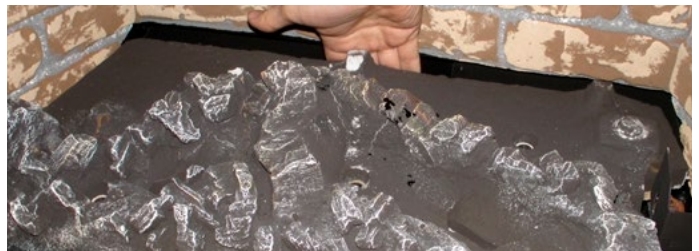

Figure 9.27b

3. Check again that the Mixing Tube is still inside the Rear Burner Support by grasping the rear of the Burner and pulling up. If the Mixing Tube is properly installed, the Log Burner will not move. If the Burner does rise up, stop and trouble shoot this situation. The Log Burner will not operate safely if this connection is not proper.



Figure 9.28b

Accent Light Replacement (Linear)

Replacement of the fireplace accent lights can be performed with a few simple steps. The accent lights are located beneath the burner. We recommend that if you need to replace one light, that you replace them all at the same time. Another option would be to replace them at the same time as your annual service.

- 1). Disconnect the electrical and gas supply to the unit.
- 2). Remove the door / safety barrier from the unit.
- 3). Remove the burner assembly.
- 4). There are 5 light bulbs in this appliance. They are removed by pulled them straight up out of their receptacles. New bulbs can be bought at most national hardware stores or through your Montigo dealer. See specs page for information on bulbs. If you supply your own bulbs, do not use greater than 20 watt bulbs.

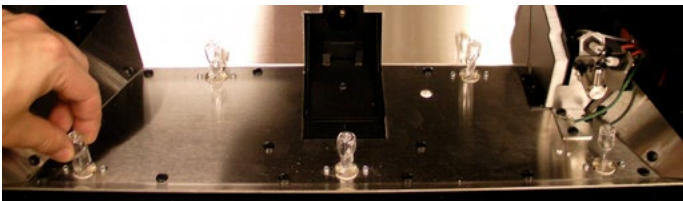

Figure 10.0

- 5). When installing the new bulbs, try to not contaminate the bulb with your hands. Using gloves or some type of paper during installation will help to prolong the life of the bulb.

Accent Light Replacement (Traditional)

Replacement of the fireplace accent lights can be performed with a few simple steps. The accent lights are located at the top of the fireplace near the front on either side. Although they can be changed without removing any components, it would be easier to remove the Fireplace Panels and Upper Retaining Clip.

We recommend that if you have a need to replace one bulb, you replace them all at the same time. Another option would be to replace them at the same time as your annual service.

- 1). Disconnect the electrical and gas supply to the unit.
- 2). Remove door and safety screen barrier from the unit.
- 3). See the section on Fireplace Panel Installation for information on how to remove the Panels. Once they have been removed, the Upper Panel Retainers can be removed.



Figure 10.0

- 4). To remove a bulb, pull it out of it's socket. New bulbs can be bought at most national hardware stores or through your Montigo fireplace dealer. See specs page for information on bulbs. If you supply your won bulbs, do not use greater than 20 watt bulbs.



Figure 10.0

- 5). Replace the Upper Panel Retainers and Firebox Liners.

Optional Fan / Blower Replacement

The Optional Fans or Blowers supplied with your fan kit are the best quality available. These Fans should provide many years of trouble free service. There are 2 blowers for this appliance, one which has the motor on the right side and the other on the left side.

** If the fireplace is installed, the Gas Supply may need to be disconnected from the Appliance. If this is the case, a licensed gas fitter will need to provide this service. Images of RKFID High Output Fan Kit shown. Installation instructions are the same for RKFIDECO Economy Fan Kit.**

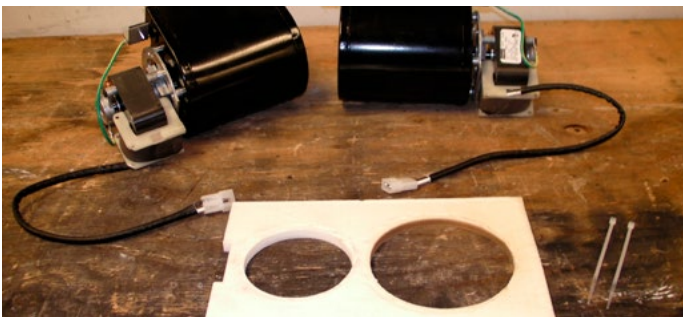

Figure 10.1

- 1). If installed, disconnect Electrical Power. Always disconnect the power when servicing any appliance.
- 2). Remove Front and Rear Faceplate. See the section on Faceplate installation for details.
- 3). Remove the Flue Collar Slide Plate. See the section on Vent Connection for details.
- 4). Remove the Fireplace from the cavity.
- 5). Remove all screws necessary to remove the Outer Shell Back.

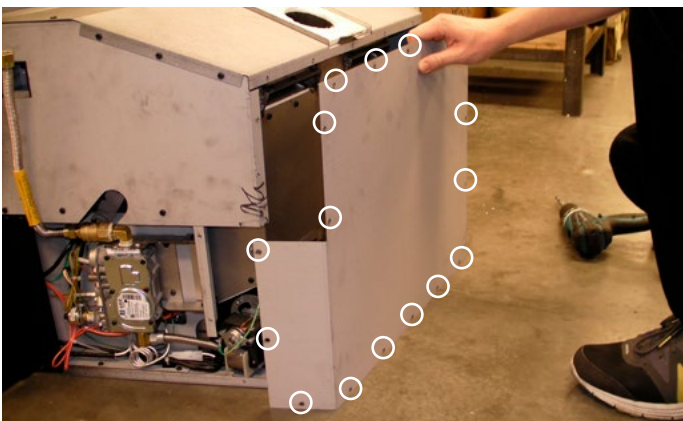

Figure 10.2

- 6). Cut the Zip Strap holding the Fan Wire Harness.



Figure 10.3

- 7). Cut the Zip Strap that holds the Fan Wire Harness in the Valve Compartment.



Figure 10.4

- 8). Disconnect the Fan Wire Harness.

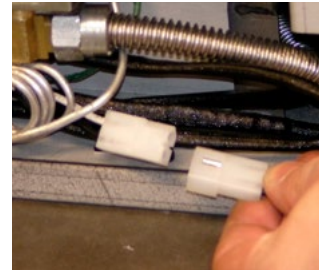

Figure 10.5

9. Disconnect the Fan Wire Harness at the back as well.

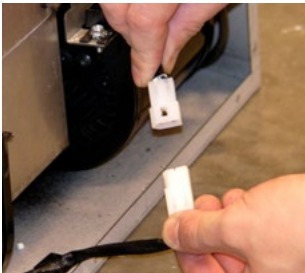

Figure 10.6

10. Remove 3 screws that mount each fan in place.

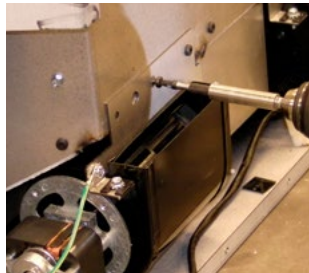

Figure 10.7

11. Remove the Blowers from the Fireplace.



Figure 10.8

12. Install both new Blowers. Secure the Wire Harness with the Zip Straps.



Figure 10.9

13. At this point, if you want to test the Blower operation, do so with the Gas Supply turned off or disconnected. To test the Blower operation, you will need to re-connect the electrical supply temporarily. Disconnect the Electrical Supply after testing the Blowers.



Figure 10.10



Figure 10.11

14. Re-install the Outer Shell Rear panel.
15. You will need to replace the Flue Collar Plate Gasket prior to re-installation into the cavity.
16. Replace the Flue Connector Plate Gasket.
17. Re-install the unit into the Cavity. See the section on Vent Connections.
18. Re-install the Face Plate Panels. See the section on Setup.
19. Re-connect the Electrical Supply.



Figure 10.12

Window Cleaning / Screen Removal

All units are supplied with a Safety Barrier (screen) to prevent accidental touching of the hot glass. Glass doors however do require periodic cleaning. How often they need to be cleaned depends on several factors like how often the appliance is run, the prevailing temperatures in your area or even air quality. When cleaning the Window, you should clean both the inner and outer surfaces. In order to clean the outer surface, you will need to remove the Safety Barrier.

See the section on Setup for details on door installation and removal.

1. On a flat work surface, place the Door with the Safety Barrier facing up. Remove 4 screws that attach the Safety Barrier to the Firebox Door.

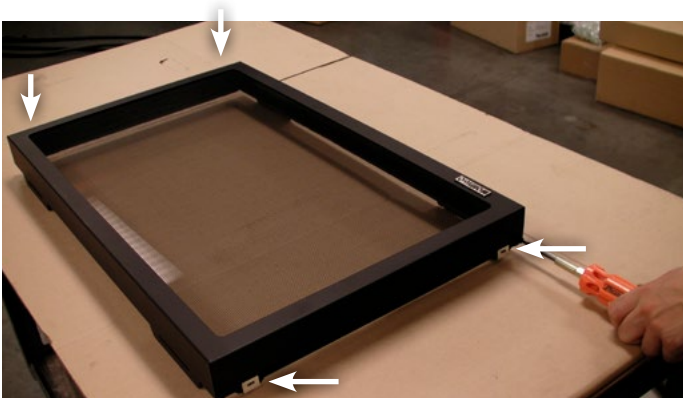

Figure 10.13

2. Lift the Safety Barrier away from the Firebox Door.
3. Using a non-abrasive cleaner, such as White-Off or Kel Kem, clean both the inner and outer surface of the Window.



Figure 10.14

4. Re-install the Safety Barrier and the Firebox Door in the reverse order they were removed.

Battery Replacement

We recommend that the batteries in this appliance be replaced at the start of each heating season even if they appear to be operational. You do not want to find out that you have dead batteries during a harsh winter storm. If you use your appliance a lot, they may need to be replaced more than once a year. See the section on Installation for information on the Battery installation for the Controller Backup. See the section on Remote Operation for information on how to install batteries in the hand held Remote Control.

Heat Exchanger Bypass

This appliance was designed and built to meet newly proposed rules of efficiency proposed by Federal Regulatory Agencies. A great deal of engineering time was spent to ensure this appliance would provide years of reliable and durable service while operating at a very high efficiency level. Keeping this in mind, there may be several conditions where this level of efficiency may not be desirable. If you are operating this appliance at a very high altitude or in extremely cold climates, start-up may be difficult. There may also be a situation where the high level of efficiency isn't wanted such as if the unit is located in a very small room and the heat output is simply too great. An optional bypass has been designed into the heat exchanger which when removed reduces the operational efficiency by approximately 10%. If it is desired, you can utilize the bypass by following these simple steps.

1. Always disconnect the electrical supply to the appliance. Shut off the fuel supply to the appliance before any service work is done.
2. Remove the Door, Firebox Panels and Burner. See the appropriate sections in this manual for instructions on those procedures.
3. Remove the right and left hand Upper Firebox Liner Retainers.



Figure 10.15

4. Remove 3 screws that hold the Firebox Baffle in location.

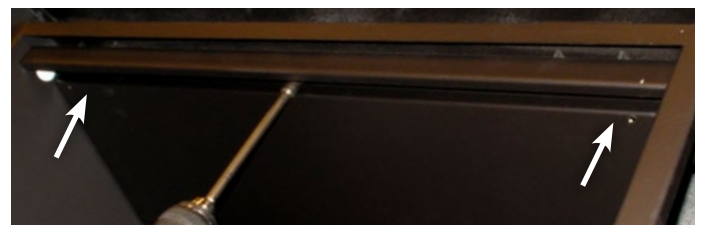

Figure 10.16

- The Firebox Baffle can be lowered at the front and then pulled forward away from 2 studs that secure the rear.

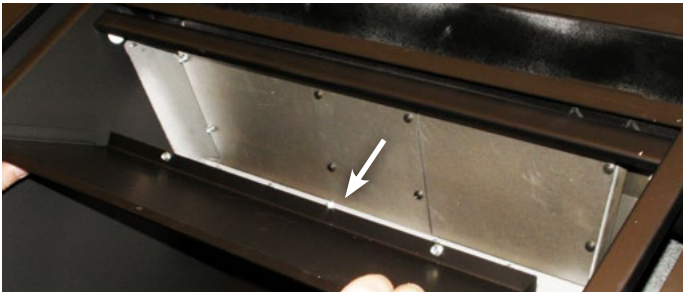

Figure 10.17

- Remove the 4 screws that secure the bypass plate to the bottom of the Heat Exchanger.

CAUTION: Screws may be tight. Use WD40 to help reduce the risk of screws stripping or breaking heads.

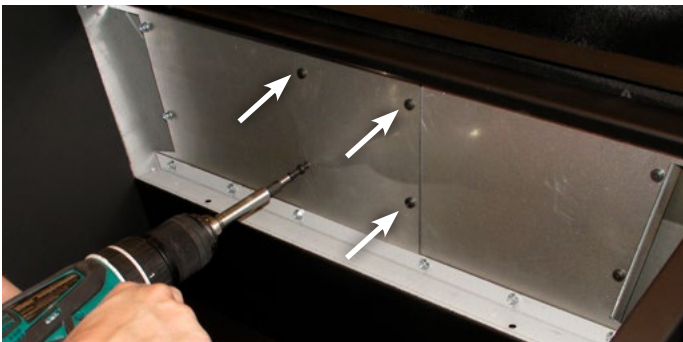

Figure 10.18

- Once the Restrictor has been removed, it is important that you return the screws to their locations again.

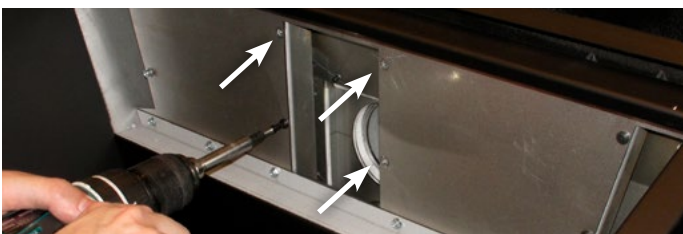

Figure 10.19

- Re-install the Firebox Baffle, left and right Upper Firebox Panel Retainers, Firebox Panels and Burner assembly and door.

Pilot Maintenance / Replacement

We suggest throughout this manual that maintenance on this product should be performed yearly. This is the best practice in order to keep your fireplace insert running reliably for many years to come. One of the items that should be inspected yearly and may need service is the Pilot Burner Assembly. The Pilot Burner Assembly is responsible for lighting the appliances and provides the safety mechanism to ensure that the appliance performs safely. In order to service the pilot, the Door, Burner Assembly, Log set etc. must first be removed. There are specific sections in the manual that cover those procedures. Replacing the pilot can be performed with the following steps.

- Disconnect Gas and Electrical Supply to the Appliance. You will need to have the unit outside the install to access the Valve location. If the unit has already been installed, see the sections on removing the Faceplate Panels and Vent Connections.
- Remove the Firebox Panels and Burner Assembly (see appropriate sections)
- Remove the 2 heat shields and insulation that cover the pilot assembly.

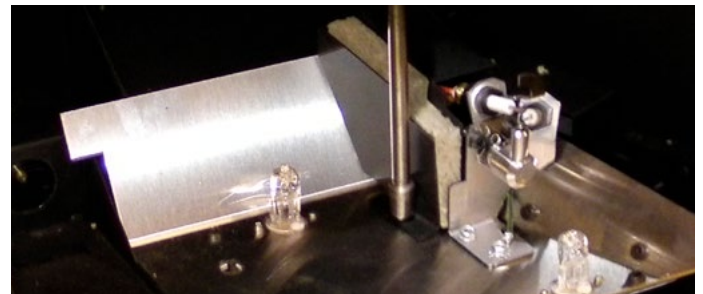

Figure 10.20

- Remove the screw securing the pilot wire cover and remove pilot wire cover.
- Remove the 2 screws securing the right side of the light reflector and remove part.

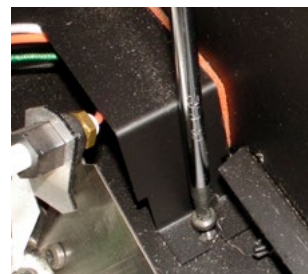

Figure 10.21

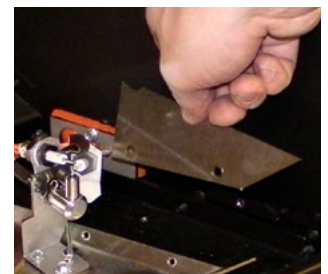

Figure 10.22

6. Remove the 2 screws that secure the pilot assembly and ground wire to the floor of the firebox.

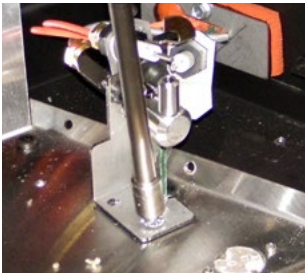

Figure 10.23

7. Remove the 2 screws securing the pilot bulk head plate and gasket to the firebox wall.

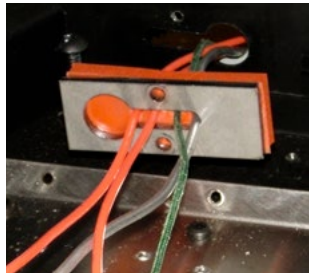

Figure 10.24

8. Remove the screws securing the valve mounting bracket. Swing valve out. Disconnect the pilot line from the bottom of the gas valve.

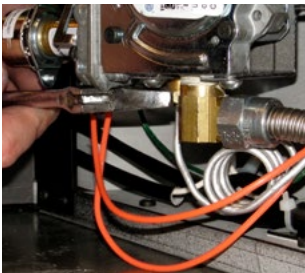

Figure 10.25

9. Remove the 2 screws securing the top of the control mounting bracket to the outer shell of the fireplace.

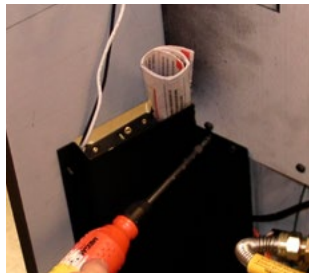

Figure 10.26

10. Feed the 2 electrical lines from the control board to the side of the unit.



Figure 10.27

11. From the inside of the firebox, pull the pilot assembly, bulk head plate, gasket and 3 lines through the firebox and out of the unit. Leave the ground wire in the firebox.



Figure 10.27

12. Install the replacement Components in the reverse order, through the Firebox wall. Install the Pilot Assembly Bracket to the Firebox floor with 2 screws. Pass the wires through rubber gasket. Make sure the pilot gas line goes through the far right hole of the gasket and the cuts in the gasket face up. Make sure that the Ground Wire, Star Washer and screw are assembled to the bottom of the Pilot Mounting Bracket as shown in the picture below.



Figure 10.28

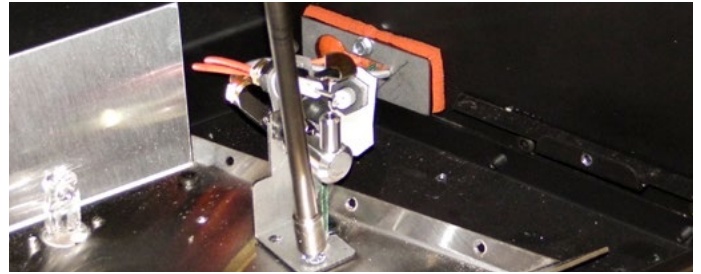

Figure 10.29

13. Using a round object, like a socket wrench, loop the excess pilot line into a coil. Be very careful to not kink the line.



Figure 10.30

15. Attach the Pilot line back into the valve, being very careful not to over-tighten the line.

16. Feed the 2 electrical wires in between the shell of the unit and the Control Board and plug them into the appropriate terminals on the control board.

17. Tie up excess wires and zap strap. Take care to not pinch or kink wires and pilot gas line.

18. Reverse these steps for reinstallation. Re-connect Gas and Electrical supply.

Control Board Replacement

1. Disconnect the appliance from the main power and shut off any gas supply prior to performing any maintenance.
2. Remove the Front Faceplate. See the appropriate section for instruction on Faceplate removal.
3. Carefully cut the zip strap that secures some of the wires from the top of the Control Board.
4. Unplug all of the electrical connections on the left and right side of the board.



Figure 11.0

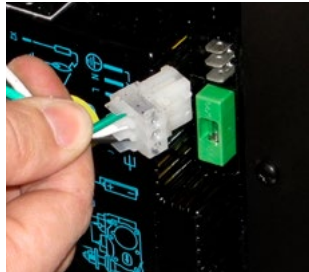

Figure 11.1

5. Remove the screws that fasten the board to the Mounting Bracket.
6. Remove and replace the board with the new unit.



Figure 11.2

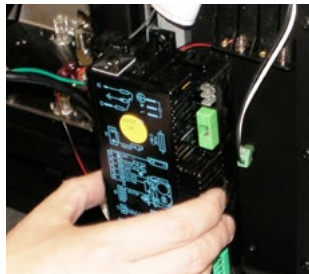

Figure 11.3

7. Stick the little Zip Strap and Retaining Pad to the top of the Control Board.
8. Using the Zip Strap, secure all the wires neatly into the Control Box Area. Re-connect the Electrical and Gas supply.

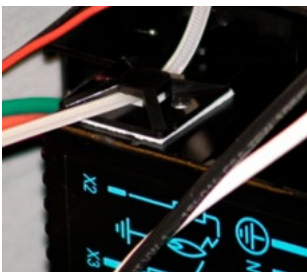

Figure 11.4



Figure 11.5

Control Board Fuse Replacement

1. Disconnect the appliance from the main power and shut off any gas supply prior to performing any maintenance.
2. Remove the Front Faceplate. See the appropriate section for instruction on Faceplate removal.
3. The Fuse is in a plastic retainer, located on the right side of the Control Board. The Plastic Retainer plugs into the Control Board as a Cable End would. You may have to gently use a screw driver to wiggle this away from the Control Board.

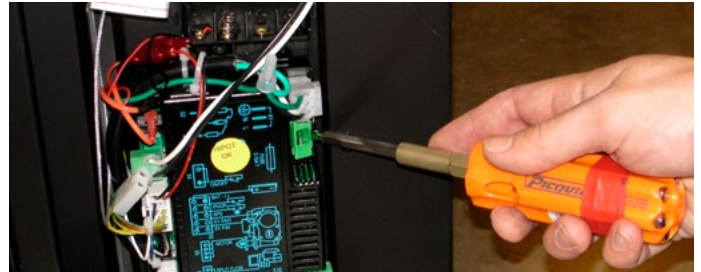

Figure 11.6

4. Remove and replace the Fuse from the Plastic Retainer.

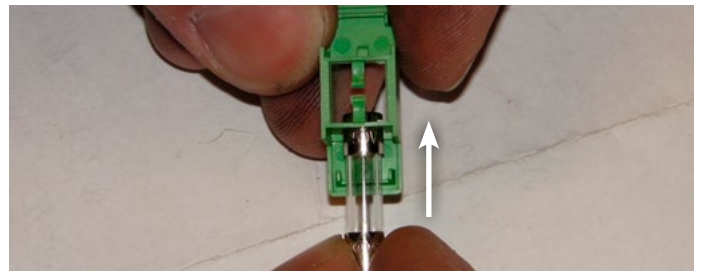

Figure 11.7

4. Re-install the Plastic Retainer into the Control Board.
5. Re-install the Front Faceplate.
6. Re-connect Electrical and Gas supply to the appliance.

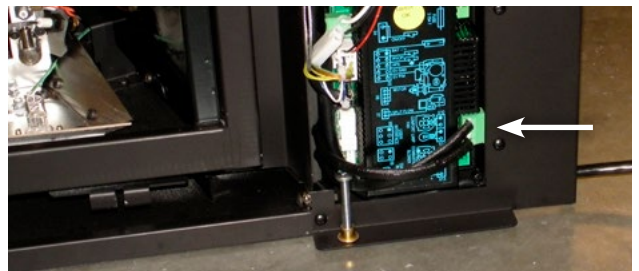

Figure 11.8

Section 7: Cleaning

Cleaning

When the fireplace is first activated, there may be some smoke and a visible film may be left on the glass. This is a normal condition, and is the result of burning of protective coatings on new metal.

- Glass must be cleaned periodically to remove any film (which is a normal by-product of combustion) which may be visible. Film can easily be removed by removing the door. Handle the door carefully, and clean it with non-abrasive, non-ammonia based glass cleaners. One of the most effective products is Kel-Kem.
- During the initial firing, Silicone seals will "off gas", leaving a visual deposit of a white substance on combustion chamber walls. This can easily be removed using normal household products.
- Use a vacuum cleaner or whisk broom to keep the control compartment, burner, and firebox free from dust and lint.

NOTICE

Do not use ammonia or abrasive cleaners on the glass, they will permanently etch the surface. Use an approved gas fireplace cleaner such as Kel-Kem or White off.

Annual inspection list for determining safe operation of a direct vent gas fireplace

- 1) Inspect and operate the pressure relief mechanism to verify relief mechanisms are free from obstruction to operate.
- 2) Clean glass window with a suitable fireplace glass cleaner. Abrasive cleaners must not be used. Be careful not to scratch the glass when cleaning.
- 3) Inspect the operation of the flame safety system Pilot or Flame rectification device.
- 4) Inspect and ensure the lighting of the main burner occurs within 4 seconds of the main gas valve opening. Visual inspection should match that outlined in the appliance instruction manual. Inspect primary air openings for blockage.
- 5) Inspect condition of vent and vent terminal for sooting or obstruction and correct if present.
- 6) Vacuum and clean any debris in the firebox that is not supposed to be there.
- 7) Test and measure the flame failure response time of the flame safety system. It must de-energize the safety shutoff in no more than 30 seconds.
- 8) Check all accessible gas-carrying tubes, connections, pipes and other components for leaks.

Vent Maintenance / Inspection

Part of the annual maintenance on this appliance should include a thorough inspection of the entire Venting and Termination. Vent inspection should include:

Roofing Inspection and repair should only be performed by a licensed and qualified roofing professional.

• CONNECTION TO THE FIREPLACE

- Make sure that the attachment of the venting to the top of the Appliance is tight, secure and that no corrosion has affected the venting's integrity.
- Make sure that both vents (incoming & outgoing) are secure and that these flexible liners have not been kinked, restricted or damaged in any way.
- Make sure there are no "dips" in the venting. Condensation can collect and affect the performance of the Fireplace if the venting is not vertical in all areas.

• ROOF TERMINATION

- Make sure that all sealing materials are in good condition and that there is no opportunity for moisture to access the building.
- Make sure there are no signs of corrosion to the Vent Termination or Roof Flashing
- Make sure there are no signs of intrusion by any birds or pests of any kind. Make sure animals have not built any nests anywhere in the vicinity of the Vent Termination.

• CONNECTION TO THE VENT TERMINATION

- If you have to re-seal a Vent Termination or Roof Flashing, firstly make sure the Venting is secure to the Termination or Vent Adaptor. Make sure there are no signs of corrosion anywhere in the venting system.

Troubleshooting

SIT Proflame 2:

PROBLEM	SOLUTION
Pilot Igniter won't spark	<ol style="list-style-type: none"> 1. Check the master override switch and turn ON 2. Ensure main power is ON and new batteries are installed in the remote control and backup battery pack 3. Make sure remote is synced with control board. 4. Check the 3.15A fuse in the control box and replace if necessary 5. Make sure remote is not in smart or thermostat mode. 6. Check ignitor wire is connected to the control board and is not damaged
Pilot Igniter sparking, but Pilot burner will not light	<ol style="list-style-type: none"> 1. Verify the Inlet and Manifold Gas Pressure are within acceptable limits 2. Check all connections to gas valve 3. Check fuel supply valves and emergency shut off valve is open 4. Check wiring connections from control board to valve
Pilot lights, but Main burner will not Light	<ol style="list-style-type: none"> 1. Check and verify all wiring connections as per the wiring diagram. 2. Verify the inlet and Manifold Pressure are within acceptable limits
Fans not working	<ol style="list-style-type: none"> 1. Ensure main power is ON and is plugged in (fireplace may be operating on back up batteries). 2. Check the 3.15A fuse in the control box and replace if necessary 3. Make sure fans are plugged into the control board

PROBLEM	SOLUTION
Lights not working	<ol style="list-style-type: none"> 1. Ensure main power is ON and is plugged in (fireplace may be operating on back up batteries). 2. Check the 3.15A fuse in the control box and replace if necessary 3. Make sure fans are plugged into the control board 4. Bulbs are burnt out
Pilot lights, but Main burner will not Light and igniter continues to spark	<ol style="list-style-type: none"> 1. Check the Pilot Flame Sensor Rod and clean with steel wool or similar. 2. Check the Pilot hood and clean with steel wool if dirty. 3. Check flame sensor wire is plugged control board and is not damaged 4. Adjust pilot flame using the pilot adjustment screw if the pilot flame is too long or too short (Flame should fully engulf the sensor rod and must be stable) 5. Check supply pressure 6. Check and make sure the ground wire from the pilot is connected to the fireplace body
Control module beeps twice when On/Off button on remote is pressed and Red LED is On	<ol style="list-style-type: none"> 1. Replace batteries in battery pack

Replacement Parts

SIT IPI Proflame 2 - Replacement Parts List

	30FID-S	30FID-L	34FID-S	34FID-L
NG Gas Valve	RGCA002	RGCA002	RGCA002	RGCA002
Propane Gas Valve	RGCA004	RGCA004	RGCA004	RGCA004
Replacement Burner	RB30FID-S	RB30FID-L	RB34FID-S	RB34FID-L
NG Pilot	RPA040	RPA041	RPA042	RPA041
Propane Pilot	RPA043	RPA045	RPA044	RPA045
Replacement Screen	RSC30FID	RSC30FID	RSC34FID	RSC34FID
Proflame 2 Control Module	RGC3095	RGC3095	RGC3095	RGC3095
Replacement Halogen Bulbs	REC1416	REC1416	REC1416	REC1416
Replacement Fuse	REC1386	REC1386	REC1386	REC1386
Replacement Fan Kit	RFKFID	RFKFID	RFKFID	RFKFID
Replacement ECO Fan Kit	RKFIDECO	RKFIDECO	RKFIDECO	RKFIDECO
Conversion Kit (NG to Propane)	GCA003	GCA003	GCA006	GCA006
Red Brick Panel Set	BRK30FIR		BRK34FIR	
Brown Brick Panel Set	BRK30FIB		BRK34FIB	
Porcelain Panel Kit	RPP30FID	RPP30FID	RPP34FID	RPP34FID
Standard Faceplate	FP30FID-01	FP30FID-01	FP34FID-01	FP34FID-01
4 Sided Faceplate	FP30FID4S-01	FP30FID4S-01	FP34FID4S-01	FP34FID4S-01
Oversized Faceplate	FP30FIDOS-01	FP30FIDOS-01	FP34FIDOS-01	FP34FIDOS-01
Standard Trim Offset Kit	FP30FIDOF	FP30FIDOF	FP34FIDOF	FP34FIDOF
Door	RDR30FID	RDR30FID	RDR34FID	RDR34FID
Log Set	LGS30FI		LGS34FI	

Appendix B: Warranty

MONTIGO RESIDENTIAL WARRANTY PROGRAM

Empire Comfort Systems, Inc. and/or Empire Comfort Systems Canada, Inc. (collectively referred to herein as "The Companies"), warrants the Montigo gas appliance (referred to herein as 'the appliance') to be free from defects in materials and workmanship at the time of manufacture. The gas appliance and related components are further subject to the terms and conditions set forth below.

This warranty covers the following Montigo product series: Distinction, Divine & Divine Outdoor (H-Series), Illume (FID Inserts), Phenom (L/P/PL-Series), Exemplar (R/RP-Series), Mahana and DelRay

Component	Coverage Period	Labor Coverage
Firebox, heat exchanger	15 years	1 year
Main burner	15 years	1 year
Gas control valve and related control components (pilot assembly, spark electrode flame sensors, thermopile)	1 year	1 year
Electrical components (internal blowers, ignition control module, wiring, switches, remote control systems, blower control module, accent bulbs)	1 year	1 year
Firebox media (logset, glass beads, river rocks)	1 year	1 year
Glass (thermal breakage)	1 year	1 year
Plated, painted finishes (including interior reflective glass) *	1 year	1 year
Refractory lining	1 year	1 year
Mesh/Glass safety barriers	1 year	1 year
Power vent termination	1 year	1 year
Montigo terminations*	10 years	1 year
Montigo venting (excluding termination)	15 years	1 year

* Exterior painted surfaces exempt

QUALIFICATIONS TO THE WARRANTY

This Warranty only covers gas appliances installed in the United States or Canada.

To receive the benefits of this warranty, the appliance must be purchased, installed and serviced annually by a dealer authorized by The Companies for the warranty to be valid.

The gas appliance must be installed by a licensed professional in accordance with The Companies' installation instructions and local building codes. The warranty on the appliance covers only components manufactured by The Companies. The use of components manufactured or supplied by other manufacturers and used in conjunction with the appliance could create serious safety hazards, may result in the denial of certification by recognized national safety agencies and could violate local building codes. Such use may untimely void this warranty. This warranty does not cover any damages occurring from the use of any components not manufactured or supplied by The Companies.

The appliance must be subjected to normal use. The appliance is designed to burn natural gas (NG) or liquefied petroleum (LP) only. Burning conventional fireplace fuels such as wood, coal or any other solid fuel will cause damage to the appliance, produce

excessive temperatures will result in a fire hazard and void all warranties. This warranty is transferable. The appliance must remain in its original place of installation to be valid.

If the components of the appliance covered by this warranty are found to be defective within the time frame stated (see The Companies investigation of claims), The Companies will, at its option, replace or repair defective components of the appliance manufactured by The Companies at no charge and will also pay for labor costs (in accordance with schedule) incurred in replacing or repairing components. If repair or replacement is not commercially practical, The Companies will, at its sole discretion, fully discharge all obligations under the warranty by refunding the verified dealer purchase price of the appliance, excluding the cost of labor unless the labor is covered by the terms of the warranty.

This warranty covers only parts and labor as provided above. In no case shall the companies be responsible for materials, components or construction, which are not manufactured or supplied by The Companies, or for the labor necessary to install, repair or remove such materials, components or construction. All replacement or repair components will be shipped F.O.B. from the nearest Company factory.

LIMITATION ON LIABILITY

It is agreed and understood that The Companies sole obligation, and purchaser's exclusive remedy under this warranty, under any other warranty, expressed or implied, or in contract, tort or otherwise, shall be limited to repair, replacement or refund as specified above. The opinion of The Companies with respect to these matters shall be final.

In no event shall The Companies be responsible for any incidental or consequential damages caused by (but not limited to) improper installation, installation by an unqualified or unauthorized installer, accident, lack of regular maintenance, user error, abuse, misuse, Acts of God, power surges, floods, natural disasters, force majeure, defects in its appliance whether such damage occurs or is discovered before or after replacement or repair, and whether or not such damage is caused by The Companies negligence. Some jurisdictions do not allow the exclusion or limitation of incidental or consequential damages, so the above limitation or exclusion may not apply to you. The duration of any implied warranty with respect to the appliance is limited to the duration of the foregoing warranty. Some jurisdictions do not allow limitations on how long an implied warranty lasts, so the above limitation or exclusion may not apply to you.

Appendix B: Warranty Continued

EXCLUSIONS TO WARRANTY

Corrosion or rust of any kind due to a lack of maintenance, inadequate combustion air or improper venting and corrosive chemicals/environments, expansion and contraction of metals or minor movements of components causing noise are not covered by this warranty.

Willful misconduct (i.e. use of the appliance with problems known to the purchaser and causing further damages), including unauthorized or self-performed 'fixing' or exploration of the appliance's internal workings will void the warranty.

Appliances on which the serial number has been altered, defaced, removed or made illegible will void the warranty.

Costs incurred for diagnosis, service work, shipping and handling of defective or replacement parts are not covered under this warranty.

The published warranties are not applicable for any equipment manufactured by The Companies that has been sold direct to the consumer via internet or auction websites. The Companies do not endorse, approve or certify any online sale of its products through auction websites, online retailers or any other method of online sales direct to consumers.

INVESTIGATION OF CLAIMS AGAINST WARRANTY

The Companies reserve the right to investigate any and all claims against this warranty and decide upon method of settlement.

The Companies are not responsible for work done without written consent of The Companies.

The Companies shall in no event be responsible for any warranty work done without first obtaining the Companies written consent.

The Companies employees and dealers have no authority to make any warranties to neither alter this warranty nor authorize any remedies in addition to or inconsistent with those stated within this warranty.

IF WARRANTY SERVICE IS NEEDED

To make a claim under this warranty, contact your installing dealer or contractor. The installing dealer is responsible for providing service and will contact the companies to initiate warranted parts replacements. In the event the installing dealer is unavailable, contact your nearest authorized Montigo dealer (www.Montigo.com) or contact Montigo direct at techsupport@montigo.com. Ensure you have your sales receipt and the model and serial number of your appliance.

DO NOT ATTEMPT TO DO ANY SERVICE WORK YOURSELF

If you cannot locate the installing dealer, or nearest dealer/distributor, you must notify The Companies in writing.

USA Offices

6955 Salashan Parkway
Ferndale WA, 98248
techsupport@montigo.com

Canadian Offices

27342 Gloucester Way
Langley, BC V4W 4A1
techsupport@montigo.com

The terms and conditions of this warranty may be altered or amended from time to time without prior notice.

WARRANTY PERIOD: Warranty coverage begins on the date of original purchase. In the case of new construction, warranty coverage begins on the date of first occupancy of the dwelling or six months after the sale of the product by an independent, authorized Company dealer/ distributor, whichever occurs earlier.

Appendix C: Amendment

(Gas Fireplace / Equipment sold in the State of Massachusetts)

5.08: Modifications to NFPA-54, Chapter 10

- (1) Revise NFPA-54 section 10.5.4.2 by adding a second exception as follows:

Existing chimneys shall be permitted to have their use continued when a gas conversion burner is installed, and shall be equipped with a manually reset device that will automatically shut off the gas to the burner in the event of a sustained back-draft.

- (2) Revise 10.8.3 by adding the following additional requirements:

- (a) For all side wall horizontally vented gas fueled equipment installed in every dwelling, building or structure used in whole or in part for residential purposes, including those owned or operated by the Commonwealth and where the side wall exhaust vent termination is less than seven (7) feet above finished grade in the area of the venting, including but not limited to decks and porches, the following requirements shall be satisfied:

1. **INSTALLATION OF CARBON MONOXIDE DETECTORS.** At the time of installation of the side wall horizontal vented gas fueled equipment, the installing plumber or gas fitter shall observe that a hard wired carbon monoxide detector with an alarm and battery back-up is installed on the floor level where the gas equipment is to be installed. In addition, the installing plumber or gas fitter shall observe that a battery operated or hard wired carbon monoxide detector with an alarm is installed on each additional level of the dwelling, building or structure served by the side wall horizontal vented gas fueled equipment. It shall be the responsibility of the property owner to secure the services of qualified licensed professionals for the installation of hard wired carbon monoxide detectors
 - a. In the event that the side wall horizontally vented gas fueled equipment is installed in a crawl space or an attic, the hard wired carbon monoxide detector with alarm and battery back-up may be installed on the next adjacent floor level.
 - b. In the event that the requirements of this subdivision can not be met at the time of completion of installation, the owner shall have a period of thirty (30) days to comply with the above requirements; provided, however, that during said thirty (30) day period, a battery operated carbon monoxide detector with an alarm shall be installed.
2. **APPROVED CARBON MONOXIDE DETECTORS.** Each carbon monoxide detector as required in accordance with the above provisions shall comply with NFPA 720 and be ANSI/UL 2042 listed and IAS certified.
3. **SIGNAGE.** A metal or plastic identification plate shall be permanently mounted to the exterior of the building at a minimum height of eight (8) feet above grade directly in line with the exhaust vent terminal for the horizontally vented gas fueled heating appliance or equipment. The sign shall read, in print size no less than one-half (1/2) inch in size, "GAS VENT DIRECTLY BELOW. KEEP CLEAR OF ALL OBSTRUCTIONS".

4. **INSPECTION.** The state or local gas inspector of the side wall horizontally vented gas fueled equipment shall not approve the installation unless, upon inspection, the inspector observes carbon monoxide detectors and signage installed in accordance with the provisions of 248 CMR 5.08(2)(a)1 through 4.

- (b) **EXEMPTIONS:** The following equipment is exempt from 248 CMR 5.08(2)(a)1 through 4:

1. The equipment listed in Chapter 10 entitled "Equipment Not Required To Be Vented" in the most current edition of NFPA 54 as adopted by the Board; and
 2. Product Approved side wall horizontally vented gas fueled equipment installed in a room or structure separate from the dwelling, building or structure used in whole or in part for residential purposes.
- (c) **MANUFACTURER REQUIREMENTS - GAS EQUIPMENT VENTING SYSTEM PROVIDED.** When the manufacturer of Product Approved side wall horizontally vented gas equipment provides a venting system design or venting system components with the equipment, the instructions provided by the manufacturer for installation of the equipment and the venting system shall include:
1. Detailed instructions for the installation of the venting system design or the venting system components; and
 2. A complete parts list for the venting system design or venting system.
- (d) **MANUFACTURER REQUIREMENTS - GAS EQUIPMENT VENTING SYSTEM NOT PROVIDED.** When the manufacturer of a Product Approved side wall horizontally vented gas fueled equipment does not provide the parts for venting the flue gases, but identifies "special venting systems", the following requirements shall be satisfied by the manufacturer:
1. The referenced "special venting system" instructions shall be included with the appliance or equipment installation instructions; and
 2. The "special venting systems" shall be Product Approved by the Board, and the instructions for that system shall include a parts list and detailed installation instructions.
- (e) A copy of all installation instructions for all Product Approved side wall horizontally vented gas fueled equipment, all venting instructions, all parts lists for venting instructions, and/or all venting design instructions shall remain with the appliance or equipment at the completion of the installation.
- (3) After NFPA-54 section 10.10.4.2 add a new section 10.10.4.3 as follows:
- When more than four gas appliances are to be vented through a common gas vent or common horizontal vent manifold, a plan of the proposed vent installation shall be submitted to the Inspector and the serving gas supplier for review and approval.

Extraction from: Massachusetts Rules and Regulations

5.00: Amendments To 2002 Edition Of ANSI Z223.1-NFPA-54

30FID-S
30FID-L
34FID-S
34FID-L
Gas Insert